



CV Tools

2 0 1 5



señalización vial

• Conos de señalización CVTools	06
• Conos de señalización JSP	07
• Camisa reflectante C.2	07
• Conos de señalización Oxford	08
• Cinta Tensaconos	09
• Cinturón retráctil	10
• Balizas de señalización	11
• Powerflare	14
• Conjunto panel	15
• Linternas	16
• Semaforos portátiles	18
• Secuenciales Led	21
• Luz Led señales metálicas	21
• Bastón luminoso	21
• Abanderado electromecánico con Led	22
• Robot de señalización carretera	22
• Cintas de señalización reflectante adhesiva	23
• Cintas de señalización	24
• Cintas de señalización personalizadas	28
• Rollo cinta marcaje suelo	29
• Cinta adhesiva carretera	29
• Cintas de señalización alta visibilidad	30
• Placa carga sobresaliente	30
• Triángulo de preseñalización de peligro	30
• Placas	30
• Cartel vehículo especial	31
• Rotativo halógeno	31
• Rotativo carretilla elevadora	31
• Avisador carretilla elevadora	31
• Poste señalización con base	32
• Cadena de plástico	32
• Banderolas quitamiedos	32
• Tubos PVC naranja Ituor	32
• Banderas de señalización	33
• Señal precaución suelo mojado	33
• Captafaros flexible para muro	33
• Señal Stop-Paso	34
• Manga viento	34
• Hito divergente	34
• Hitos	35
• Soportes metálicos para señales	37
• Base multiperfil caucho	38
• Reductores de velocidad	39
• Reductor lenticular	40
• Pie caucho para valla	40
• Tope muelle carga - Parking	41
• Esquinas protección	41
• Tope Parking	41
• Espejos	42
• Cepos Parking	43



utillaje construcción

• Guardacantos acero inox.	88
• Nivel acero inox. alto brillo	88
• Perfil "U" acero inox.	89
• Tubo encofrado estriado	90
• Tapón y Cono para tubo encofrado	90
• Tapón estanco	90
• Cono y tapón encofrado liso	90
• Elubax con tapones	90
• Separadores y crucetas	91
• Distanciador cuña	91
• Base horca pescante	92
• Base guardacuerpo	92
• Cono guardacuerpo	92
• Setas protectoras	92
• Guardavivo Yeso	93
• Junquillo	93
• Guardacantos	93
• Berengeno	94
• Guardavivo monocapa	94
• Juntas de dilatación	94
• Sacos Big Bag	95
• Saco Rafia	95
• Saco plástico escombros	95
• Ecopate	96



herramientas

• Lápices	76
• Mezclador de pintura	76
• Clavo yesero	76
• Frotas esponja	77
• Toldos polietileno	78
• Mallas fibra vidrio	79
• Mallas ocultación	79
• Malla andamio	80
• Malla protección naranja	80
• Malla señalización monofilamento	80
• Malla anti-hierba	80
• Bolsas encofrador	81
• Octómetro	81
• Rodillo de marcar	81
• Tirolésa	82
• Caldereta de obra y Capazo	82
• Cuerdas	83
• Azuletes	84
• Tiralíneas	85



seguridad laboral

• Gafas protectoras	98
• Cascos auditivos	99
• Tapones auditivos	99
• Rodilleras alicatador	100
• Faja elástica protección lumbar	100



vestuario laboral

- Chalecos reflectantes
- Chaleco reflectante rejilla
- Tirantes alta visibilidad
- Traje de agua

102
103
103
104



material eléctrico

- Focos halógenos

106



01 señalización vial



02 herramientas



03 utillaje construcción



04 seguridad laboral



05 vestuario laboral



06 material eléctrico



señalización vial



señalización vial

01

● **Tetrápodo**



Ref.: 1634

Altura: 50 cm.
Bandas reflectantes.
Material: PVC blando.
Color: Naranja.
Unidades por caja: 10.

● **Cono de señalización 1 pieza**



Ref.: 1635

Altura: 32 cm.
Banda reflectante.
Material: PVC blando naranja fluo.
Palet: 360 conos.
Unidades por caja: 20.

● **Cono de señalización 1 pieza**



Ref.: 1636

Altura: 50 cm.
Peso: 1.250 Kg.
Bandas reflectantes.
Material: PVC blando naranja fluo.
Palet: 360 conos.
Unidades por caja: 20.



● Cono de señalización 2 piezas



Ref.: 1638 **CE**

Altura: 50 cm.
Peso: 1 Kg.
Camisa reflectante homologada nivel 1.
Material: base composite parte superior PVC.
Palet: 300 conos.
Unidades por caja: 10.

● Cono de señalización 1 pieza



Ref.: 1641

Altura: 75 cm.
Camisa reflectante nivel 2.
Material: Caucho.
Palet: 125 conos.

● Cono de señalización 1 pieza



Ref.: 1639

Altura: 45 cm.
Camisa reflectante nivel 2.
Material: Caucho.
Palet: 200 conos.

● Camisa reflectante C.2



Ref.: 1600

Camisa reflectante
para cono de 51 cm.

● Camisa reflectante C.2



Ref.: 1601

Camisa reflectante
para cono de 75 cm.

● Cono de señalización 2 piezas



Ref.: 1640

Altura: 75 cm.

Peso: 3.250 Kg.

Camisa reflectante homologada nivel 1.

Material: base goma parte superior PVC.

Palet: 180 conos.

Unidades por caja: 10.

● Cono de señalización 2 piezas



● Cono de señalización 2 piezas



Ref.: 1643

Altura: 75 cm.

Peso: 6 Kg.

Camisa reflectante homologada nivel 2..

Material: base caucho parte superior PVC.

Palet: 120 conos.

Unidades por caja: 5.

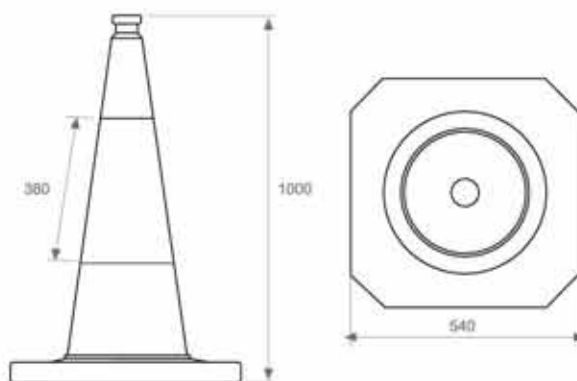

Ref.: 1645

Altura: 100 cm.

Ancho de base: 54 cm.

Peso: 8 Kg.

Camisa reflectante homologada clase 2.

Material: 2 piezas.

Palet: 100 conos.

● Cinta Tensaconos R/B y A/N 3 m.



Ref.	Descripción	Und. caja
0565	Cinta 5 cm x 3 m. R/B	20
0566	Cinta 5 cm x 3 m. A/N	20

● Cinta Tensaconos R/B y A/N 9 m.



Ref.	Descripción	Und. caja
0564	Cinta 5 cm x 9 m. R/B	10
0563	Cinta 5 cm x 9 m. A/N	10

● **Poste Plata con cinturón retráctil**



● **Poste Negro con cinturón retráctil**



Ref.: 1132

Poste Plata 1 m con cinturón retráctil 2 m x 5 cm.
Cinta roja.

Ref.: 1134

Poste Negro 1 metro con cinturón retráctil 2 m x 5 cm.
Cinta roja.

● **Cinturón retráctil Pared**



• Soporte para enganche cinta.

Ref.: 1133

Cinturón retráctil pared 2 m x 5 cm.
Cinta roja.
Cromado plata.



● Baliza de señalización - Plus



- Luz ámbar a dos caras.
- Tipo luz LED.
- Célula fotoeléctrica.
- Fijación trasera metálica.
- Argolla superior metálica.
- Tornillo cierre metálico.
- Ubicación para doble batería 6v 4R25.
- Visibilidad aprox.: Hasta 250 - 300 m.
- Tiempo estimado trabajo: Aprox. 600 - 700 h.
- Tres posiciones:
 - Encendido / Apagado.
 - Encendido (día y noche).
 - Automático con oscuridad.

Ref.	Descripción	Und. caja	Und. palet
1033	Linterna de señalización intermitente.	12	240

● Baliza de señalización - Basic



- Luz ámbar a dos caras.
- Tipo luz LED.
- Célula fotoeléctrica.
- Fijación trasera metálica.
- Argolla superior plástico.
- Tornillo cierre plástico.
- Ubicación para doble batería 6v 4R25.
- Visibilidad aprox.: Hasta 250 - 300 m.
- Dos posiciones:
 - Automático con oscuridad.
 - Encendido / Apagado

Ref.	Descripción	Und. caja	Und. palet
1033/B	Linterna de señalización intermitente.	12	240

● Baliza de señalización

- Luz ámbar a dos caras
- Tipo luz LED
- Célula fotoeléctrica.
- Fijación trasera metálica.
- Argolla superior metálica.
- Tornillo cierre metálico.
- Ubicación para 1 batería.
- Visibilidad aprox.: Hasta 250 - 300 m.
- Tiempo estimado trabajo: Aprox. 300 h.

Ref.	Descripción	Und. caja	Und. palet
1032	Linterna de señalización intermitente.	12	300



Baliza de señalización - flash leds



- Luz ámbar a dos caras.
- Tipo luz LED: 120 pcs.
- Célula fotoeléctrica.
- Fijación trasera metálica.
- Argolla superior metálica.
- Tornillo cierre metálico.
- Ubicación para doble batería 6v 4R25.
- Visibilidad aprox.: Hasta 1000-1200 m.
- Tiempo estimado trabajo: Aprox. 200 h.
- Tres posiciones:
 - Encendido / Apagado.
 - Encendido (día y noche).
 - Automático con oscuridad.

Ref.	Descripción	Und. caja	Und. palet
1035	Linterna de señalización flash Led.	10	200

Baliza de señalización - solar



- Luz ámbar a dos caras.
- Tipo luz LED.
- Célula fotoeléctrica.
- Fijación trasera metálica.
- Argolla superior metálica.
- Tornillo cierre metálico.
- Utiliza pilas recargables. Ni-MHAA / 1.5v x 2 2100 mA.
- Visibilidad aprox.: Hasta 250-300 m.
- Tiempo estimado trabajo: con 8 h. de recarga puede trabajar 120-150 horas.
- Celular solar: 140 x 25mm., 315mv-3v, Input max 120 mA.
- Tres posiciones:
 - Encendido / Apagado.
 - Encendido (día y noche).
 - Automático con oscuridad.

Ref.	Descripción	Und. caja	Und. palet
1037	Linterna de señalización solar.	10	200

Baliza de señalización Azul - flash leds



- Luz azul a dos caras.
- Tipo de luz led.
- Fijación trasera metálica.
- Tornillo cierra plástico.
- Argolla superior metálica.
- Ubicación para doble batería 6v 4R25.
- Visibilidad aprox. 200 metros.
- Dos posiciones:
 - Apagado.
 - Encendido (día noche) manual.

Ref.	Descripción	Und. caja	Und. palet
1030	Linterna de señalización flash Led.	12	200



● Luz fija Vega



- Luz roja fija a dos caras.
- Tipo luz 2 LEDES.
- Célula fotoeléctrica.
- Lente: ø 180 mm.
- Enganche trasero y argolla superior.
- Alimentación 1 o 2 baterías 4R25.
- 2 Posiciones:
 - Apagado.
 - Encendido automático con oscuridad.

Ref.	Descripción	Und. caja	Und. palet
1036	Linterna de señalización intermitente.	12	240

● Baliza de señalización Sirius



- Luz roja fija a dos caras.
- Tipo luz Multiled de alta luminosidad.
- Célula fotoeléctrica- Lente: ø 180 mm.
- Enganche trasero y argolla superior.
- Alimentación 1 o 2 baterías 4R25.
- Conforme EN 12352.

Ref.	Descripción	Und. caja	Und. palet
1039	Linterna de señalización fija.	12	240

● Baliza de señalización Queen - flash leds



- Luz roja fija a una cara.
- Tipo luz Multiled de alta luminosidad.
- Célula fotoeléctrica.
- Lente: ø 210 mm.
- Enganche trasero y argolla superior.
- Alimentación 1 o 2 baterías 4R25.
- 3 Posiciones:
 - Encendido/apagado.
 - Encendido día y noche.
 - Automático con oscuridad.
- Homologada L7-L8G.
 - Min. 25 CD.
 - Man. 100 CD.

Ref.	Descripción	Und. caja	Und. palet
1040	Linterna de señalización flash Led.	12	240

● Batería para baliza



Ref.	Descripción	Und. caja	Und. palet
1034	Batería 4R25 7 Ah.	24	1200



Maletín balizas de señalización Powerflare



Sistema 6 unidades balizas intermitentes de emergencia, diseñada especialmente para policía, bomberos y equipos de rescate o de protección civil.

- Diseño compacto. Emite luz a 360°.
- Tamaño unitario: 120 mm de diámetro y 35 mm de altura.
- El maletín incluye cargador a 220v y cargador para coche.
- Con imán adhesivo.
- Nueve programas diferentes de iluminación.
- Disponible en azul y naranja.

Ref.	Descripción	Und. caja
1029/AZUL	Maletín 6 und. señalización intermitente luz azul .	5
1029	Maletín 6 und. señalización intermitente luz naranja .	5



● Conjunto panel R/B + base caucho



• No incluye baliza.

- Fácil transporte.
- Panel R/B reflectante.
- Preparado para colocar balizas.



Ref.	Descripción	Und. caja	Und. palet
1686	Panel R/B + Base caucho.	1	50



● **Linterna Recargable Super Led**



ON

OFF



Ref.: 1689

Linterna recargable 12/220v.
LED 3w. Basic.
Bateria 2500 mAh Ni-Cd.
Cono señalización Amarillo.
Unidades caja: 20.
Cuerpo de aluminio.

● Linterna Recargable Profesional



Ref.: 1690

Linterna Super Led 12/220v.
3w Profesional.
Unidades caja: 1.
Cuerpo de aluminio.
Bateria 3,6v - 2500 MAM Ni/MA.



● Cono Linterna



Ref.: 1692

Cono para linterna Super Led Profesional.
Unidades caja: 1.

● Paleta Linterna

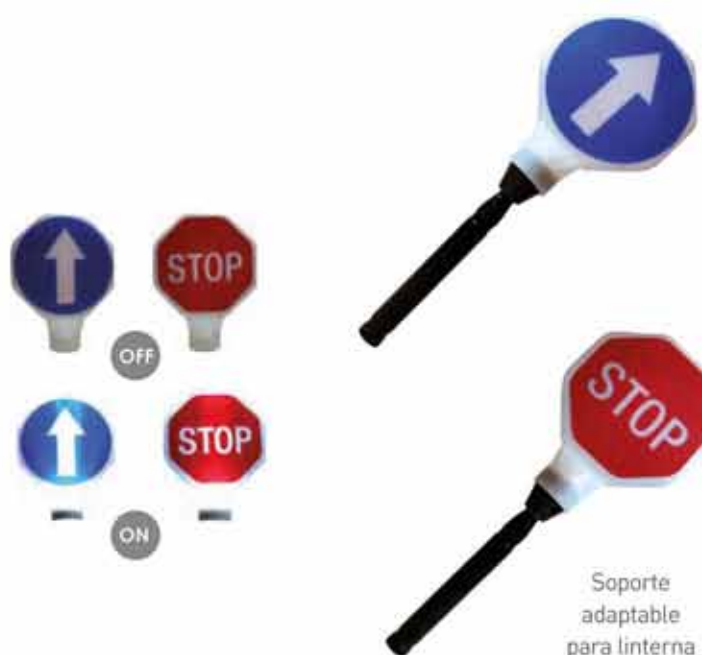

Ref.: 1691

Paleta Stop - Paso para linterna.
Super Led Profesional.
Unidades caja: 1

Soporte adaptable para linterna recargable CVTools.



● Pareja semáforos Led - Mod. A

- Cuerpo con carcasa de 3 focos tricolor:
 - Rojo ø 300 mm.
 - Ámbar/Verde ø 200 mm.
- Viseras anti-sol.
- Caja porta-baterías y programador.
- Ruedas y manecilla de transporte.
- Programador de cuarzo:
 - Sincroniza tiempos de vaciado (ambos semáforos en Rojo).
 - Ciclos en Verde.
 - Ámbar intermitente
- Programa de tiempos hasta un máximo de 99 seg. por ciclo:
 - 600 m de obra a 25 km/h.
 - 1000 m de obra a 40 km/h.
- Alimentación: Batería 12V [No incluida].



Ref.	Descripción	Und. caja
1671	Pareja de semáforos portátiles halógenos.	1
1680	Centralita semáforos modelo A.	1

● Pareja semáforos portátiles Led - Mod. B

- Sistema de semáforos formado por: 2 semáforos con carro metálico porta-baterías con ruedas, 3 luces (Rojo 300 mm, Ámbar 200 mm y Verde 200 mm), central de control y cables de conexión y alimentación.
- Funciona con bombillas normales de 25 vatios 12V. y alimentación baterías de 180 A/H 12V. [Baterías No incluidas].
- Tiempo estimado de trabajo: 100 horas.
- Utiliza centrales de control de cuarzo CSQ 2V. Las centrales disponen de indicadores luminosos que indican las fases del semáforo, el nivel de carga de la batería y la sincronización efectuada, las centrales mantiene la sincronización cuando pasan de una función a otra, esto permite poner en amarillo parpadeante por la noche y el ciclo normal del semáforo durante el día sin tener que proceder a una nueva sincronización.
- Interruptor azul: controla 3 funciones:
 - Ciclo Rojo, Amarillo y Verde.
 - Parpadeo.
 - Apagado semáforo.
- Interruptor verde y rojo: programación de tiempos.
 - 12 Posibilidades de 10 a 250 segundos.
- Interruptor negro: sincronización de señales.



Ref.	Descripción	Und. caja
1672	Pareja semáforos portátiles halógenos cuarzo.	1
1679	Juego centralita (recambio).	1

● Semaforo portatil plegable Led Mod. C

Sistema de semáforos formado por: 2 semáforos con carro metálico porta-baterías con ruedas, 3 luces (Rojo 300 mm. Ámbar 200 mm. y Verde 200 mm.), central de control y cables de conexión y alimentación.

Este semáforo gracias a la nueva tecnología Led nos proporciona un producto que emite más luz que el semáforo tradicional y menor consumo de energía (aprox. 50%). De hecho necesita baterías de 80 Ah 12V, proporcionándole una autonomía aproximada de 4 días.

Utiliza centrales de control de cuarzo CSQ 2V. Las centrales disponen de indicadores luminosos que indican las fases del semáforo, el nivel de carga de la batería y la sincronización efectuada, las centrales mantiene la sincronización cuando pasan de una función a otra, esto permite poner en amarillo parpadeante por la noche y el ciclo normal del semáforo durante el día sin tener que proceder a una nueva sincronización.

- Interruptor azul: controla 3 funciones:
 - Ciclo Rojo, Amarillo y Verde.
 - Parpadeo.
 - Apagado semáforo.
- Interruptor Verde y Rojo: programación de tiempos.
 - 12 Posibilidades de 10 a 250 segundos.
- Interruptor Negro: sincronización de señales.
- Baterías de 12V No incluidas.

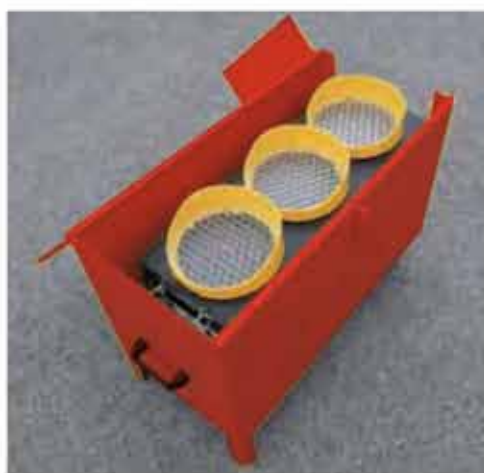

Ref.	Descripción	Und. caja
1674	Semáforo portatil modelo C - Leds.	1
1679	Juego centralitas (recambio).	1



● **Secuenciales Led 5 elementos destello**



El sistema secuencial de luces, se utiliza para advertir a los vehículos sobre los cambios de carril, desviaciones y dirección a seguir.

Sincornización por destello.
 5 focos + 5 pies + 5 Balizas R/B.
 Alimentación: 4 x 4R25 6V. [No incluidas].
 Distancia de transmisión: max. 10 m.
 Foco: 96 leds de alta intensidad.
 Diámetro foco: 230 mm.

Ref.	Descripción	Und. caja
1675	Secuencial led inalámbrica por destello.	1

● **Secuencial led 5 elementos radiofrecuencia**



Secuencial Leds 5 elementos.
 5 focos + 5 pies + 5 Balizas R/B.
 Sincronización vía radio.
 Reconocimiento automático de la secuencia.
 Regulación automática de intensidad lumin.
 Alimentación: 2 baterías 4R25 (No incluidas).
 Homol. L8H.

Ref.	Descripción	Und. caja
1677	Secuencial led inalámbrica por radiofrecuencia.	1

● Luz Led señal metálica



Ref.	Descripción	Und. caja
1683	Juego 3 focos led para señal metálica ø 100 mm.	5

● Bastón luminoso



Ref.: 1697

Bastón luminoso LED ambar.
Tiempo operat, aprox. 400/h 2 bater alkalinas.
Longitud total: 53 cm.
Longitud tubo luz: 33 cm.
Peso aprox: 220 gr.
Aliment: 2 Baterias 1,5 v.(Baterias no incluidas).
Unid. caja: 50



Abanderado electrónico con led

- El abanderado electromecánico se compone de una estructura metálica formada de un carro portabaterías, con ruedas y manilla de transporte, y un panel vertical ambos realizados en chapa metálica galvanizada, un foco de led de 230 mm. de alta intensidad luminosa y una bandera señaladora fluorescente accionada a través de un brazo articulado, por un motor eléctrico.
- En el panel vertical además del foco led, es aplicada una película reflectante de color blanco y rojo.
- El uso de una fuente de luz de alta intensidad luminosa como el foco led en conjunto con la película reflectante y la bandera permite al abanderado, tener una visibilidad muy alta y señalar el peligro a los usuarios, aun estando estos a una larga distancia.
- El foco led y el motor eléctrico de la bandera son controlados por dos interruptores independientes.
- Las ruedas y la manilla permiten manejar con extrema sencillez el abanderado.

UTILIZACIÓN

- La utilización del abanderado es aconsejada en todas las situaciones de peligro derivadas por restricciones en las carreteras, circulación alternada en un único carril de circulación o en presencia de obras viarias.
- La colocación del abanderado antes de una zona potencial de peligro permite a los usuarios percatarse del peligro con antelación y avanzar con mayor prudencia.

CARACTERÍSTICAS ELECTRÓNICAS

- Alimentación 12V d.c. [Baterías no incluidas]. [es posible utilizar baterías estándar].
- Fotorresistor para la regulación automática de la intensidad luminosa.
- Promedio de absorción del foco led: 0.6 A.
- Promedio de absorción del motor eléctrico: 1 A.
- Fuente luminosa: foco led color ámbar 230 mm con 120 diodos led de alta intensidad.
- Dos interruptores independientes.
- 1 Motor eléctrico para la bandera señaladora de 12 voltios.
- Autonomía: la autonomía del abanderado depende del número de amperios/horas (A/H) de la batería.

CARACTERÍSTICAS MECÁNICAS

- Estructura de chapa galvanizada.
- Superficie reflectante 250 x 1250 mm. con película de color blanco y rojo.
- Presencia de ruedas y manilla para facilitar el movimiento. - Bandera señaladora fluorescente de color naranja 80 x 60 cm.

DIMENSIONES

- Altura: 1680 mm.
- Anchura: 360 mm.
- Profundidad: 570 mm.
- Espacio para la batería: 320 x 540 x 260 mm.
- Peso: (sin batería) 18 kg.



Ref.	Descripción	Und. caja
1678	Abanderado Electromecánico con led - 230 mm.	1

Robot de señalización carretera

Ref.: 1681

- Robot de señalización con bandera:
Peso aprox. 40 Kg. Sin batería.
Alimentación: Batería 12v (90 - 100 Ah).
No incluida.



● Cinta reflectante adhesiva señalización

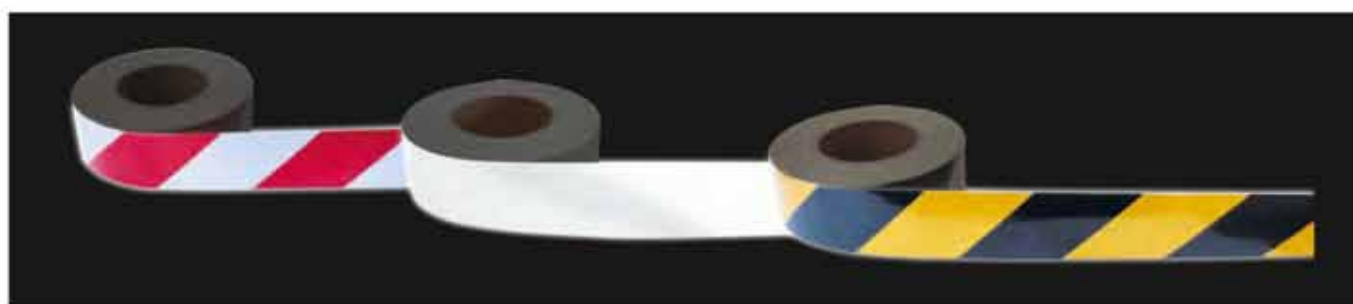

Ref.	Descripción	Und. caja
1555	Rollo de 45 m. - Ancho 5 cm. - Rojo/Blanco.	25
1550	Rollo de 45 m. - Ancho 5 cm. - Blanco.	25
1556	Rollo de 45 m. - Ancho 5 cm. - Negro/Amarillo.	25



● Cinta reflectante



Ref.	Descripción	Und. caja
1565	Rollo cinta Roja c/reflectante. - 10 cm x 200 m.	20

● Cinta adhesiva



Ref.	Descripción	Und. caja
1563	Rollo de 132 m. - Ancho 5 cm. - Amarillo/Negro.	36
1564	Rollo de 132 m. - Ancho 5 cm. - Rojo/Blanco.	36



● **Cinta de señalización Roja y Blanca**



Ref.	Descripción	Und. caja
1571	7 cm x 200 m. - Galga 130. 1 cara	24

● **Cinta de señalización Roja y Blanca**



Ref.	Descripción	Und. caja
1567	10 cm x 200 m. - Galga 400. 2 caras	12
1570	10 cm x 200 m. - Galga 300. 2 caras	20
1570/B	10 cm x 200 m. - Galga 300. 1 cara	10

● **Cinta de señalización Negra y Amarilla**

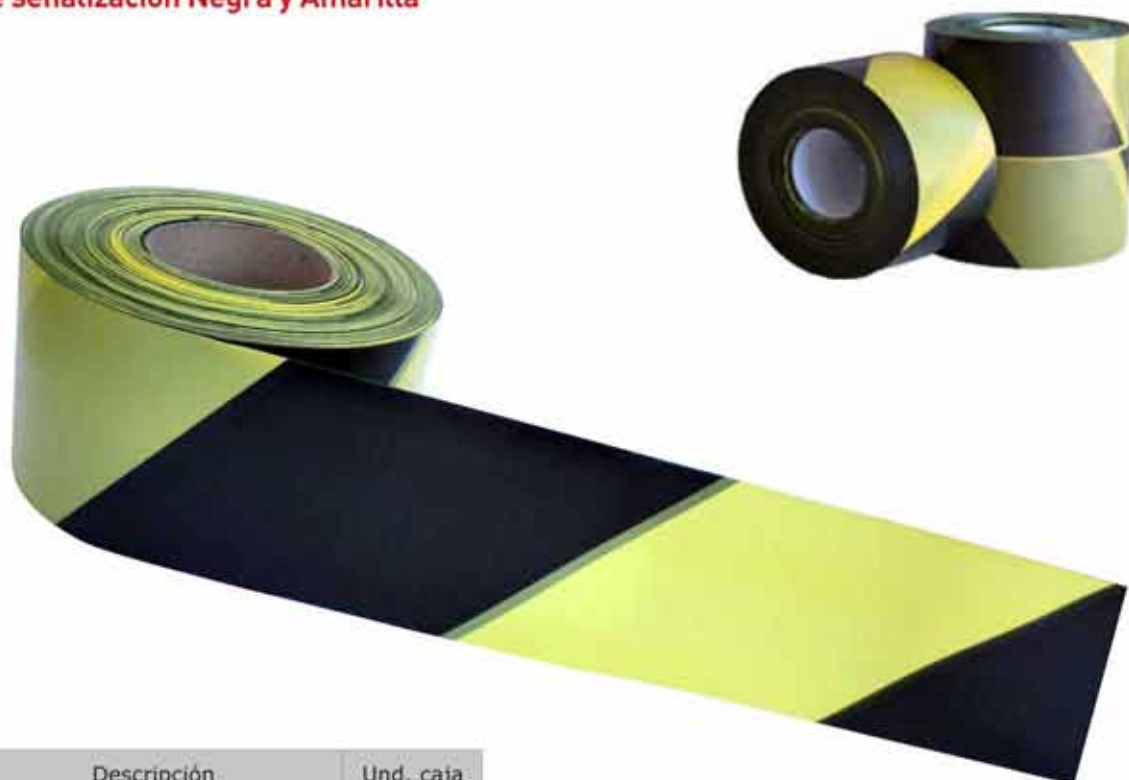

Ref.	Descripción	Und. caja
1579	10 cm x 200 m. - Galga 400. 2 caras	12
1562	10 cm x 200 m. - Galga 300. 2 caras	20

● **Cinta de señalización Roja y Blanca con caja dispensadora**



Ref.	Descripción	Und. caja
1566	10 cm x 200 m. - Galga 400. Envase: Caja con 1 rollo. 2 caras	12
1569	10 cm x 200 m. - Galga 300. Envase: Caja con 1 rollo. 2 caras	12

● **Cinta de señalización Negra y Amarilla con caja dispensadora**



Ref.	Descripción	Und. caja
1578	10 cm x 200 m. - Galga 400. Envase: Caja con 1 rollo. 2 caras	12

● **Cinta de señalización Roja y Blanca con caja dispensadora**

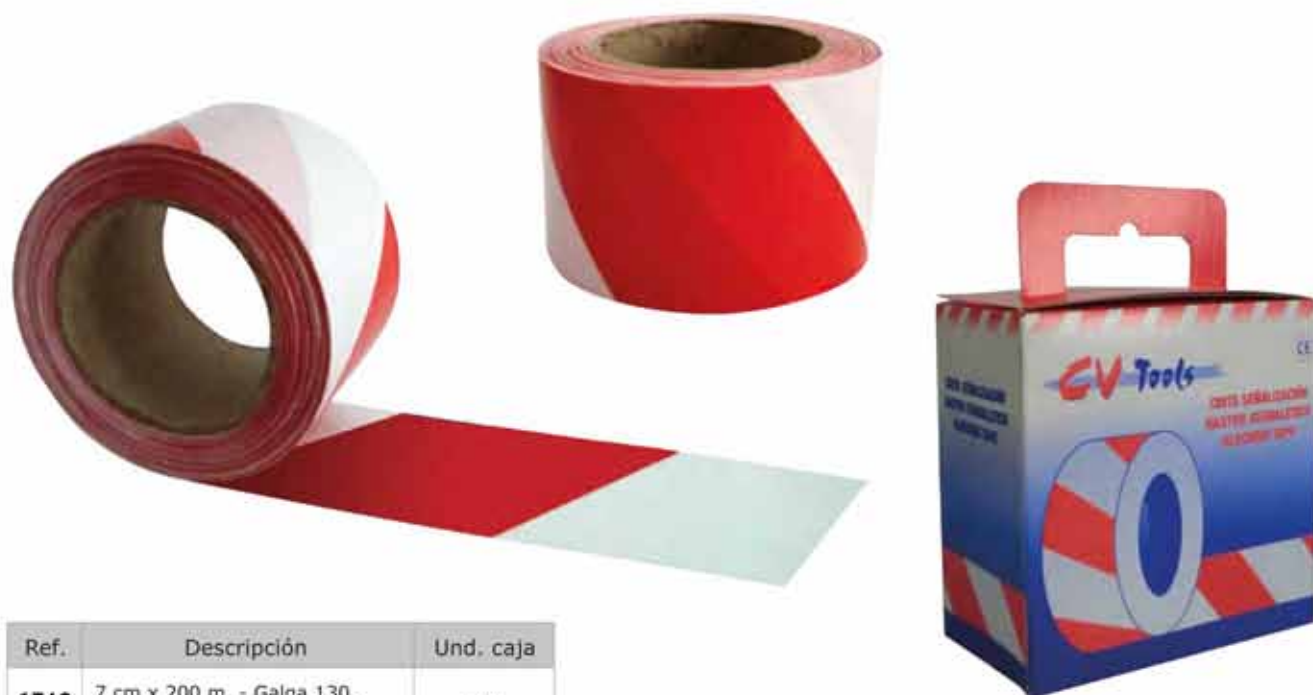

Ref.	Descripción	Und. caja
1568	7 cm x 200 m. - Galga 130. Envase: Caja con 1 rollo. 1 cara	30



● Cinta de señalización Policia Local



● Cinta de señalización subterránea cables eléctricos



Ref.	Descripción	Und. caja
1575	15 cm x 200 m. - Galga 300.	12



● Cinta de señalización subterránea tubería gas

Ref.	Descripción	Und. caja
1576	10 cm x 200 m. - Galga 300.	20



Ref.	Descripción	Und. caja
1574	15 cm x 200 m. - Galga 300.	12

● Cinta de señalización subterránea telecomunicaciones



● Cinta de señalización subterránea tubería agua



Ref.	Descripción	Und. caja
1572	15 cm x 200 m. - Galga 300.	12

Ref.	Descripción	Und. caja
1573	15 cm x 200 m. - Galga 300.	12



● **Cintas señalización personalizadas**

Fabricamos todo tipo de cintas personalizadas.



● Rollo cinta marcaje suelo 5 cm. x 40 m. x 1,2 mm.



Ref.	Descripción
1545	Rollo cinta marcaje suelo 5 cm x 40 m x 1,2 mm. Amarilla.
1546	Rollo cinta marcaje suelo 5 cm x 40 m x 1,2 mm. Roja.

● Cinta adhesiva Carretera



Ref.	Descripción
1577	Rollo cinta adhesiva amarilla para marcaje temporal suelo. Medida: 10 cm x 60 m.



Señalización vehículos

Cinta señalización alta visibilidad para vehículos 3M



Cinta para marcaje perimetral de laterales y trasera de camiones.

55 mm x 50 m.

Norma ECE 104 y especificaciones DOT-C2.

3M

Ref.	Descripción
1548	Rollo cinta 55mm x 50 mts. DG983-72 ECE Rojo 1R/CTN
1549	Rollo cinta 55mm x 50 mts. DG983-71 ECE 104 Amarillo 1/CTN

Placa carga sobresaliente V-20

Ref.	Descripción	Und. caja
0667	Señal V-20 homologada 50 x 50cm.	10



Triángulo de preseñalización de peligro homologado



Ref.	Descripción	Und. palet
0725	Jgo. de triángulos homologado vehículo.	1

Placas

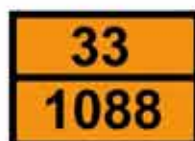

Ref. 0710

Placa mercancías peligrosas 30x40 numeración troquelada.



Ref. 0711

Disco nacional 20cm ø limitación velocidad Aluminio, Reflex N2.



Ref. 0712

Placa servicio público 75 x 150mm. Aluminio, Reflex N2.



Ref. 0714

Señal Transporte de animales vivos. Aluminio, 30 x 22cm.



Ref. 0713

Placa servicio público 120 x 225mm. Aluminio, Reflex N2.

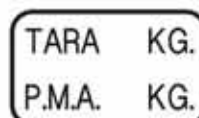

Ref. 0715

Señal adhesiva TARA - P.M.A. 130 x 330mm.



Ref. 0716

Placa Vehículo lento 365mm lado Aluminio, Reflex N2.



Ref. 0717/L

Placa 1130 x 200mm. Vehículo largo Reflex N2. Hom. Europea R70



Ref. 0717

Jgo. Placas 565 x 200mm. Vehículo largo Reflex N2. Hom. Europea R70

"Para otros modelos consultar"

Señalización vehículos

● Cartel vehículo especial

Ref.	Descripción
0718	Señal vehículo especial sin luz, soporte magnético 74x31x22cm.
0718/LUZ	Señal vehículo especial con luz, soporte magnético 74x31x22cm.



Sin Luz



Con Luz

● Rotativo halógeno Mod. Plus

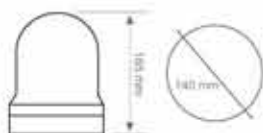

Base magnética + ventosa

Ref.: 1682

Rotativo Halógeno 12v 55w.
Cable rizado 3 m. longitud.
Conector de mechero.
Motor con engranaje de larga duración.
Homologado R65.
Unid. caja: 1.



● Rotativo halógeno Mod. Basic



Ref.: 1684

Rotativo Halógeno 12v.
Cable rizado con Conector de mechero.
Unid. caja: 1.

● Rotativo carretilla elevadora



Ref.: 1687

Rotativo Halógeno 12v 21w.
Luz para carretilla elevadora con bombilla incluida.
Unid. caja: 1.



● Avisador carretilla elevadora



Ref.: 1693

Avisador acústico 97dB.
Unid. caja: 1.



● **Poste señalización con base**



Base rellenable de agua o arena.

Ref.	Descripción	Und. caja
1125	Poste Altura 1 m.	10

● **Cadena de plástico**



Bolsas de 25 m.

Ref.	Descripción	mts. caja
1126	Grueso 6 mm. - Rojo y Blanco.	200
1127	Grueso 8 mm. - Rojo y Blanco.	100
1128	Grueso 6 mm. - Amarillo y Negro.	200
1129	Grueso 8 mm. - Amarillo y Negro.	100

● **Banderolas quitamiedos**



Ref.	Descripción	Und. caja
1580	Con reflectante - Bolsas 10 m.	600 m.
1581	Sin reflectante - Bolsas 10 m.	600 m.

● **Tubos PVC 1m. naranja fluor**



Los tubos de señalización le permiten marcar sus obras de manera fácil y segura.

La banda reflectante 3M cumple las normativas de la CE en esta materia.

El tubo de PVC reciclado, de alta resistencia, nos da una gran versatilidad en su instalación.

Ref.	Descripción	Und. caja	Und. palet
4720	Standard Con reflectante.	25	2200
4721	Standard Sin reflectante.	25	2200
4722	Extra con reflectante.	25	2200

● **Bandera de señalización Mod. Plus**



Ref.	Descripción	Und. caja
0575	Bandera 50 x 48 cm. - palo 90 cm. Material: Poliester.	50

● **Bandera de señalización Mod. Basic**



Ref.	Descripción	Und. caja
0575/B	Bandera 60 x 60 cm. - palo 76 cm. Material: PVC.	50

● **Señal precaución suelo mojado**



Ref.	Descripción	Und. caja
0391	PVC plegable. Medida: 63 x 63 cm.	10

● **Captafaros flexible para muro**



Ref.	Descripción
0590	Captafaros flexible para muro.

● Señal Stop - Paso



Ref.	Descripción	Und. caja
0577	Señal obra Stop - Paso con mango.	50

● Señal Stop - Paso reflectante



Ref.	Descripción	Und. caja
0579	Señal obra Stop - Paso con mango.	50

● Manga viento



Ref.	Descripción
0595	Conjunto Manga Viento + Poste y Rótula.
0596	Mástil Manga Viento c/Rótula (400 x 80 Ø 2mm).
0597	Manga de Viento c/Aro (400 x 150mm), L= 1.600mm.
0598	Rótula para Manga de Viento.

● Hito divergente



Ref.	Descripción
0568	Hito de Vértice Compuesto de 1200mm x 1300mm, pantalla no reflectorizada, flechas Clase 2.



● Hito H75 - Mod. A

H 75 – HITO VÉRTICE

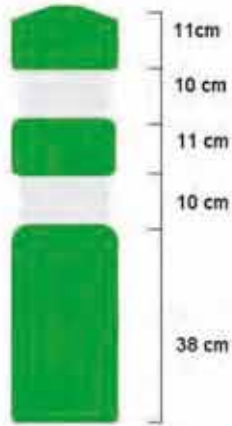

Fabricado en Polietileno especial.
Resistente a fuertes impactos.
Resistente a los rayos solares.
Sujección resistente con fijaciones.
Peso - 1,6 Kg. - Alt . 75 cm. - Diámetro 20 cm.

Ref.	Descripción	Und. caja	Und. Palet
0576	Fabricado en Polietileno especial - Verde.	6	60
0574	Fabricado en Polietileno especial - Azul.	6	60
0570	Llave colocación Hito H 75.	1	-

● Hito H75 Basculante- Mod B

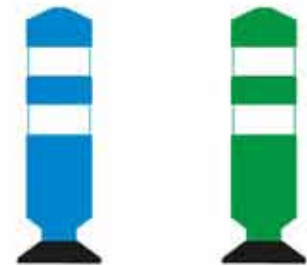

Medidas:
Altura: 80 cm.
Diámetro: 20 cm.

Ref.	Descripción	Und. caja	Und. palet
0571	Hito basculante en polietileno. Verde	6	56
0571/A	Hito basculante en polietileno. Azul	6	56



Hito Basculante - Mod. C



Medidas:
 Altura: 75 cm.
 Diámetro: 10 cm.
 Color rojo con cintas reflectantes.

Ref.	Descripción
0573	Hito basculante 75 cm.

Bolardo Acero



Colores:



Con cintas reflectantes.
 Medida: 100cm x 8cm Ø.

Ref.	Descripción
0569	Bolardo fijo.

Hito PVC Blando - Mod. E



Medidas:
 Altura: 75 cm.
 Diámetro: 10 cm.
 Color rojo con cintas reflectantes

Ref.	Descripción
0581	Hito PVC blando 75 cm.

Hito PVC Blando - Mod. D



Color disponible Negro

Ref.	Descripción	Und. caja	Und. palet
0580	Hito de 75 cm. PVC blando con tres bandas reflectantes.	6	56

● Soporte metálico para señal bolsa



Ref.	Descripción	Und. caja
0578	Soporte metálico para señal bolsa. Medida: 130 x 62 cm.	8

● Trípode gigante señal metálica M.O.P.U.



Ref.	Descripción	Und. caja
0696	Perfil pletina. Med: 110 cm altura x 100 cm base. Peso: 7,8 Kg.	4

● Trípode señal metálica

Mod. A
Perfil Tubular
Peso: 1 Kg.



Mod. B
Perfil angular
Peso: 2 Kg.



Ref.	Descripción	Und. caja
0675	Mod. A: Trípode Tubular 65 x 85 cm.	10
0695	Mod. B: Trípode Angular 65 x 85 cm.	10



● **Cruceta - Tubo para señales metálicas**

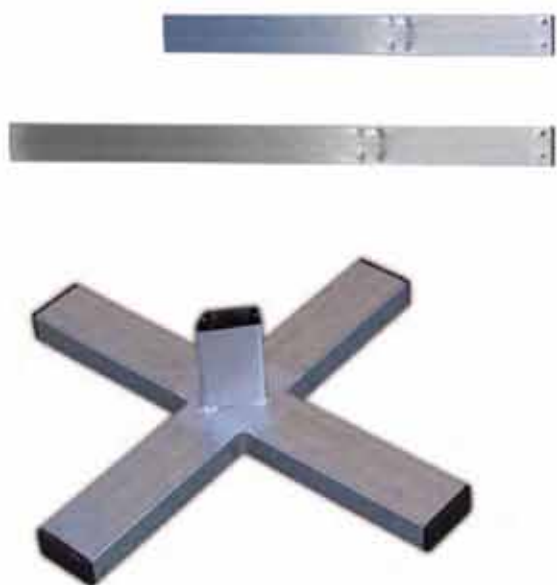

Ref.	Descripción	Und. caja
0677	Cruceta para tubo.	6
0676	Metro Tubo para cruceta - Medida: 80x40 mm.	A medida

● **Soporte de pared señal metálica**



Ref.	Descripción	Und. caja
0698	Soporte de pared señal metálica.	1

● **Base multiperfil caucho para señales metálicas**

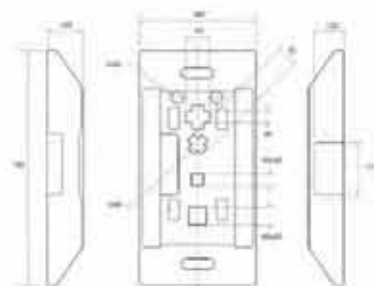

Especificaciones

Altura: 120 mm.
 Anchura: 390 mm.
 Longitud: 785 mm.
 Peso: 25 kg.



Ref.	Descripción	Und. palet
0690	Base Multiperfil.	36

● Reductor de velocidad - Mod. A

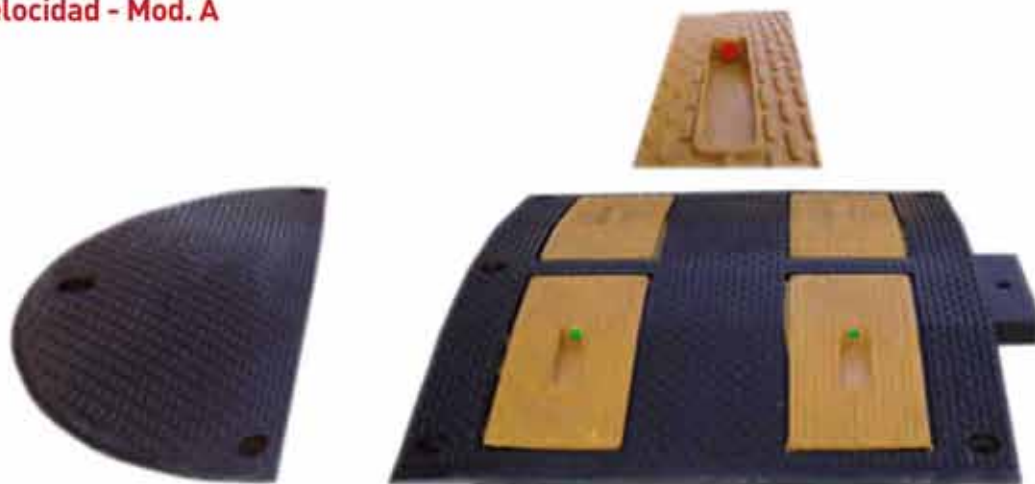

Mat. caucho reciclado



Ref.	Descripción	Peso	Und. caja	Und. palet
1903	Caucho reciclado - 50 x 60 x 5 cm.	13,50 Kg.	2	60
1904	Extremo 25 x 60 x 5 cm.	4,5 Kg.	4	120

● Banda reductora de velocidad - Mod. B



Ref.	Descripción	Peso	Und. caja	Und. palet
1902	Caucho virgen. 50 x 50 x 3 cm.	5 Kg	1	70
1908	Caucho virgen. 50 x 50 x 5 cm.	7 Kg	1	50

● Terminación reductor - Mod. B



Ref.	Descripción	Peso	Und. caja	Und. palet
1901	Caucho virgen 50 x 25 x 3 cm.	2 Kg.	1	140
1909	Caucho virgen 50 x 25 x 5 cm.	3,5 Kg.	1	100

• Tornillería recomendada

Tornillo cabeza hexagonal c/caña 140 x 8 mm.
Taco 10 mm.



● Reductor pasacables móvil

Ref.: 1900

Reductor pasacables.
 Material: Caucho.
 Ancho: 90 cm.
 Paso de rueda: 50 cm.
 Altura: 5 cm.
 Peso: 15,5 kg.
 N° de canales protección cables: 5
 - Ancho canal: 4 x 3 cm.
 - Peso: 15.5 kg.



● Reductor pasacables fijo

Ref.: 1910

Reductor de velocidad - pasacables Mod. C.
 Material: Caucho virgen.
 Medidas: 60 x 50 x 5 cm.
 N° canales: 2.
 Medidas canales: 4 cm ancho x 3 cm alto.



● Reductor lenticular



Ref.: 1912

Reductor lenticular
 Medidas: 22 x 4 cm.



● Pie caucho para valla

Especificaciones

Longitud: 770 mm.
 Altura: 120 mm.
 Ancho: 205 mm.
 Peso: 18 Kg.

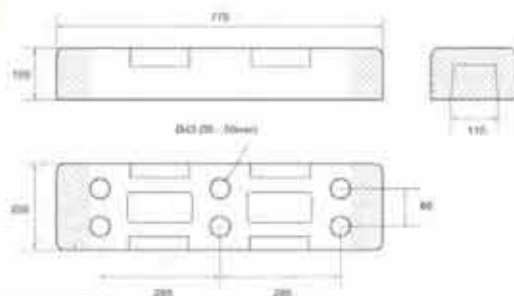

Ref.	Descripción	Und. palet
0689	Pie de caucho.	48



● **Tope muelle carga - Parking**



- Fabricado en caucho.

Ref.	Descripción
4250	Medidas: 90 x 10 x 10 cm.

● **Esquinera protección anti - golpe**



- Fabricado en Foam (Espuma)

Ref.	Descripción
4200	Esquinera anti-golpe negra/amarilla.
4201	Esquinera anti-golpe blanca/roja.

● **Esquinera protección columna Mod. A**



- Altura: 80 cm.
- Peso: 2,5 Kg.
- Tiras reflectantes de 10 cm.
- Fabricado en caucho.

Ref.	Descripción	Und. caja
4105	Esquinera.	10

● **Esquinera protección columna Mod. B**



- Altura: 80 cm.
- Peso: 2 Kgs.
- Tiras reflectantes de 10 cm.
- Fabricado en caucho.

Ref.	Descripción	Und. caja
4103	Esquinera.	10

● **Tope parking**



- Medida: 55 x 15 x 10 cm.
- Fabricado en caucho.

Ref.	Descripción	Und. caja
4104	Tope parking.	1



● Espejo circulación y soportes - Mod. Basic

Ref.	Descripción	Und. caja
4100	Espejo ø 60 cm. Antivandálico.	5
4101	Espejo ø 80 cm. Antivandálico.	1
0697	Soporte pared, Espejo ø 60 cm.	1
0697/G	Soporte pared, Espejo ø 80 cm.	1
0694	Poste redondo ø 50 mm, 3 mts. galvanizado	1
0694/G	Poste redondo ø 70 mm, 3 mts. galvanizado	1



● Espejo convexo de exterior - Mod. Plus

Ref.	Descripción
4220	TRÁFICO 50 cm.
4221	TRÁFICO 60 cm.
4222	TRÁFICO 70 cm.
4223	TRÁFICO 80 cm.
4224	TRÁFICO 90 cm.
4225	TRÁFICO 100 cm.
4226	TRÁFICO 110 cm.
4227	TRÁFICO 40 x 60 cm.
4228	TRÁFICO 60 x 80 cm.
4229	TRÁFICO 80 x 100 cm.



● Espejo convexo de interior

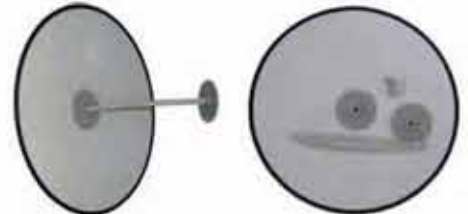

● Espejos hemiféricos



Ref.	Descripción
4213	Hemisférico 360° 60 cm.
4214	Hemisférico 360° 80 cm.
4215	Hemisférico 360° 100 cm.
4216	Hemisférico 180° 60 cm.
4217	Hemisférico 180° 80 cm.
4218	Hemisférico 90° 60 cm.
4219	Hemisférico 90° 80 cm.



Ref.	Descripción
4203	CONVEXO 30 cm.
4204	CONVEXO 40 cm.
4205	CONVEXO 50 cm.
4206	CONVEXO 60 cm.
4207	CONVEXO 70 cm.
4208	CONVEXO 80 cm.
4209	CONVEXO 90 cm.
4210	CONVEXO 40 x 60 cm.
4211	CONVEXO 60 x 80 cm.
4212	CONVEXO 30 x 30 x 38 cm.



● **Cepo Parking Mod. B con candado**



Ref.: 4099

Cepo Parking.
Cierre: Candado.
Tubo: ø 38 mm.

Dimensiones:
Ancho: 76 cm.
Alto: 47 cm.
Profundidad: 51 cm.
Und. caja: 1.



● **Cepo Parking - Mod. A con cerradura**



Ref.: 4098

Cepo Parking.
Cierre: Llave.

Dimensiones:
Alto: 51 cm.
Ancho: 30 cm.
Und. caja: 1.

● **Aparcabicis modular**

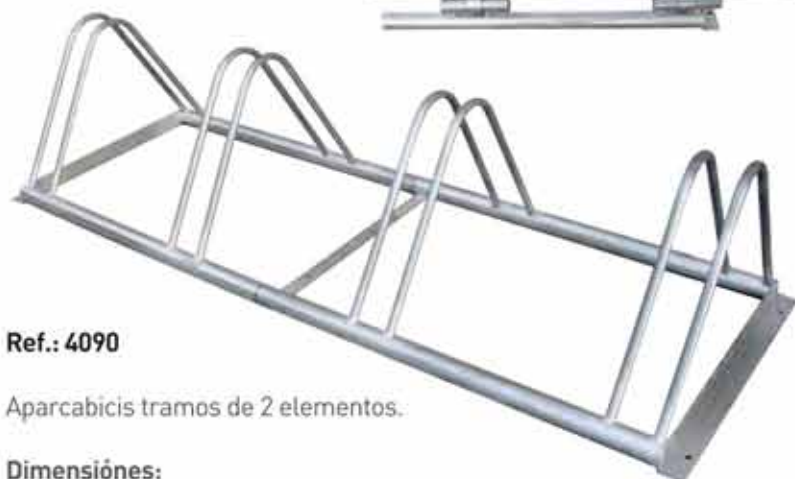

Ref.: 4090

Aparcabicis tramos de 2 elementos.

Dimensiones:
Alto: 40 cm.
Ancho: 55 cm.
Largo: 210 cm.



Módulo extremo



Módulo central



● Barrera mediana 80

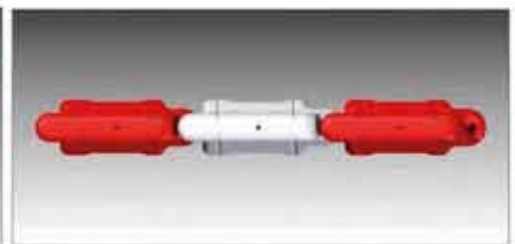
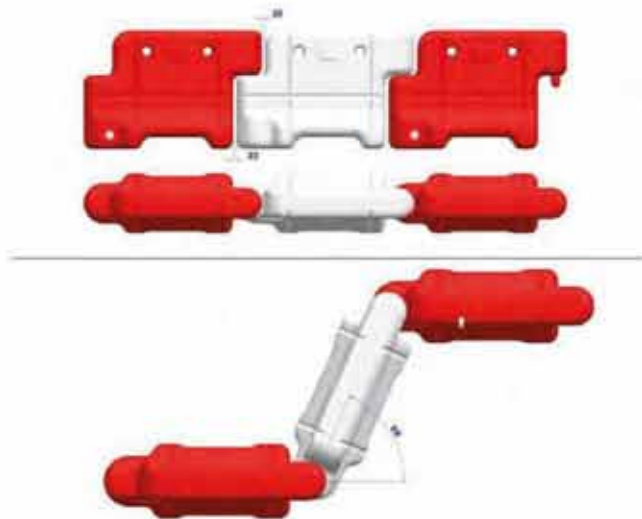
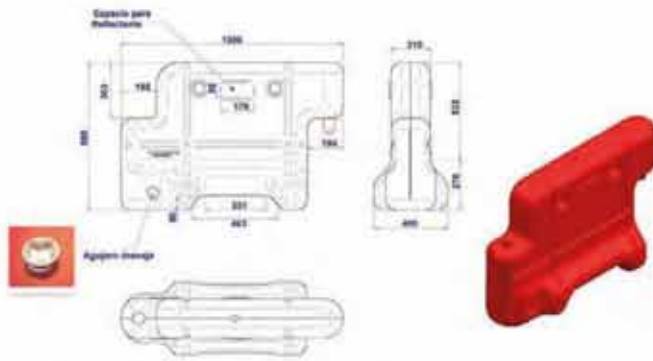

Altura: 50 cm.

Ref.	Descripción	Und. palet	Camión
1124	Barrera med. New Jersey 80 x 45 x 130 cm.	8	304



● Valla Avalon



Características

- Cumple con las especificaciones BS 7818 para restricciones depeatones haciendola ideal para control de eventos y peatones.
- Construida en polietileno de alta densidad en una pieza.
- Peso 10 Kg.

Ref.	Descripción	Color	Und. palet
1905/A	Ancho 2 m. - pata giratoria.	Azul	50
1905/N	Ancho 2 m. - pata giratoria.	Naranja	50

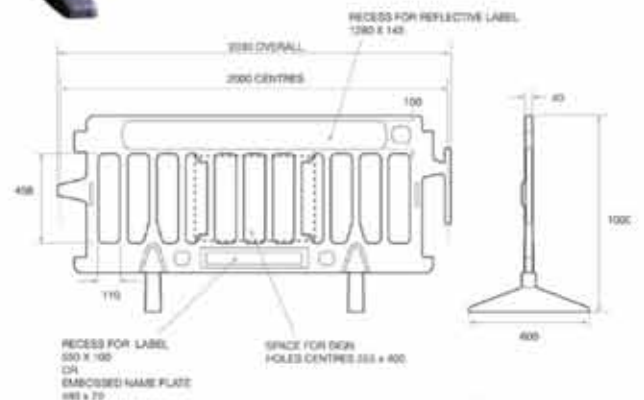

● Valla plástico soplado

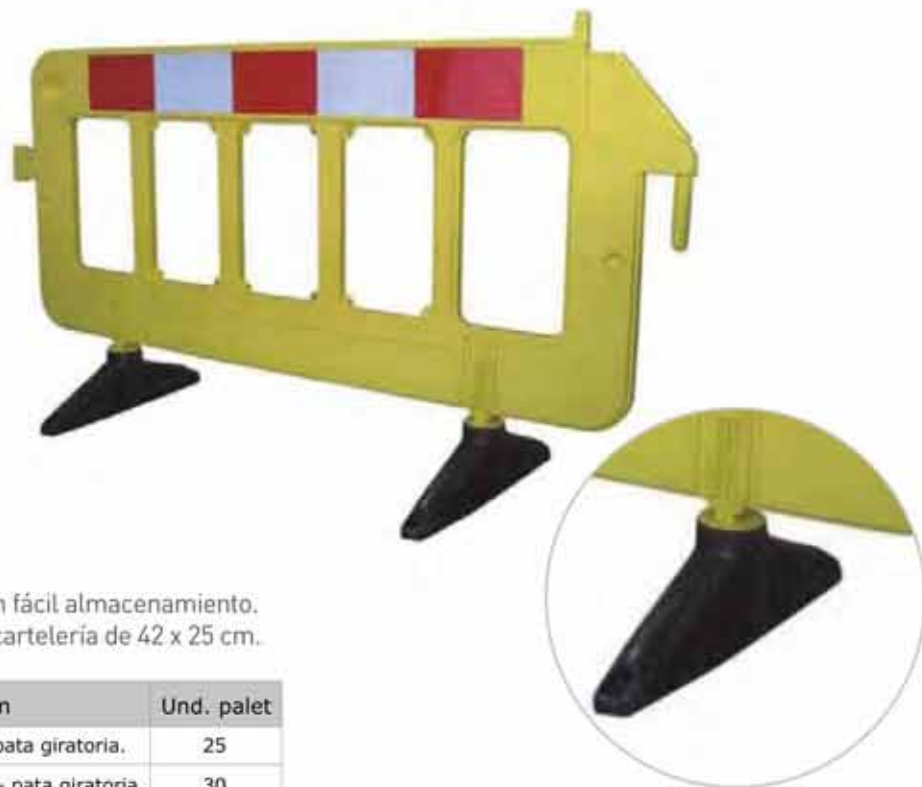

Características:

- 2 m de longitud.
- 1 m de altura total.
- Gran rigidez HDPE.
- Peso total: 14 kg.
- Color Estándar: amarillo.
- Pies desmontables para un fácil almacenamiento.
- Soportes integrados para cartelería de 42 x 25 cm.

Ref.	Descripción	Und. palet
1906	Color amarillo - 2 m. - pata giratoria.	25
1911	Color amarillo - 1,5 m. - pata giratoria.	30



● Valla metálica plegable

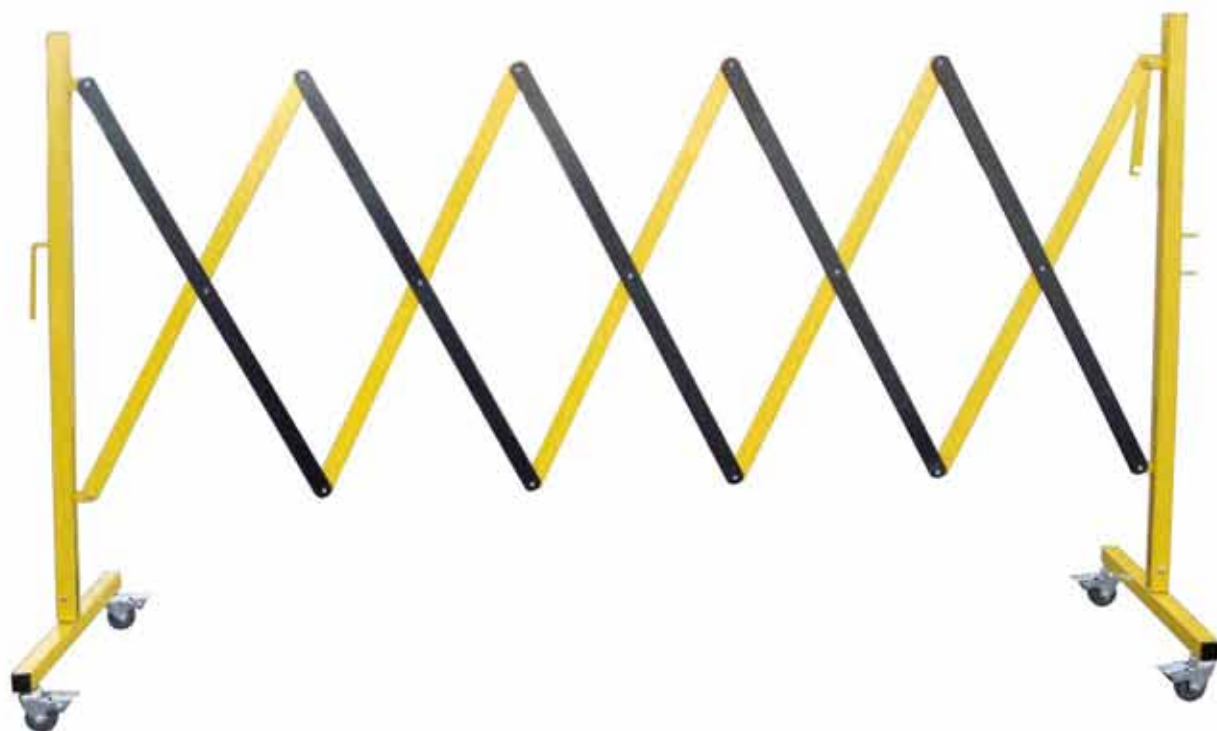

Ref.: 1915

- Valla extensible metálica 2,5 m.
- Plegable.
- Ruedas para transporte.



● Valla alcantarillado y de contención



Ref.: 1919

- Valla alcantarillado 4 puertas plástico naranja.
- También utilizada para contención.
- Plegable.
- 1,2 m cada puerta.
- Longitud total 4,8 m.
- Incluye reflectante.



Placa salva zanjas

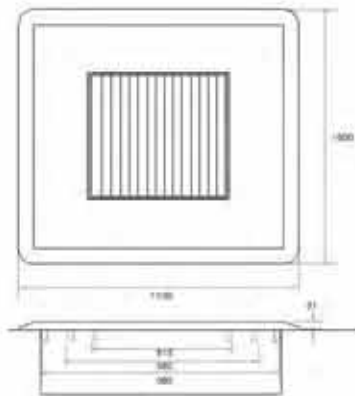
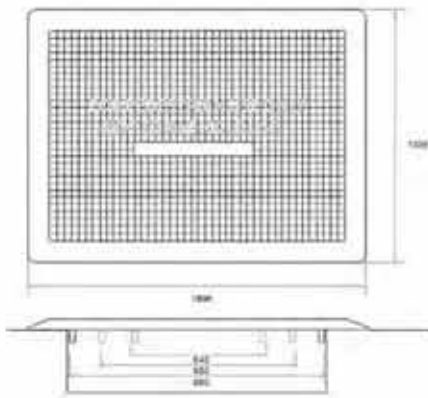
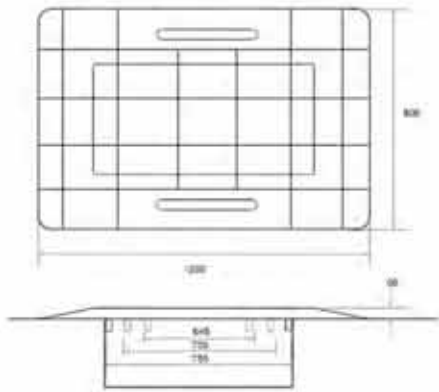

Características

Diseñadas principalmente para obras provisionales.
 Fabricado en fibra de vidrio reforzado.
 Superficie deslizante y bordes biselados para evitar tropiezos.
 Diseñadas para soportar 2.000 Kg. de peso en movimiento.

Ref.	Descripción	Und. caja
1920	Placa de 120 x 80 cm. - Peso: 12 Kg.	1
1921	Placa de 110 x 100 cm. - Peso: 15 Kg.	1
1922	Placa de 160 x 120 cm. - Peso: 33 Kg.	1



Pintura Reflectante



Novedad:

Aplicación vertical



Nuestra pintura reflectante contiene micro prismas que le confieren un grado de reflectancia o retro reflexión, encuadradas dentro de la clase RA1, de clase RA2 o de clase RA3.

Ref.:	Ref.:	Ref.:	Ref.:	Ref.:	Ref.:
7112	7115	7127	7118	7121	7124
					
Plata	Rojo	Azul	Amarillo	Negro	Verde

- Formato: 1 Kg.
- Fácil aplicación: Paleta, brocha, rodillo, pistola.
- Muy resistente a los golpes.
- Secado al tacto en 30 min.



Pintura Luminescente

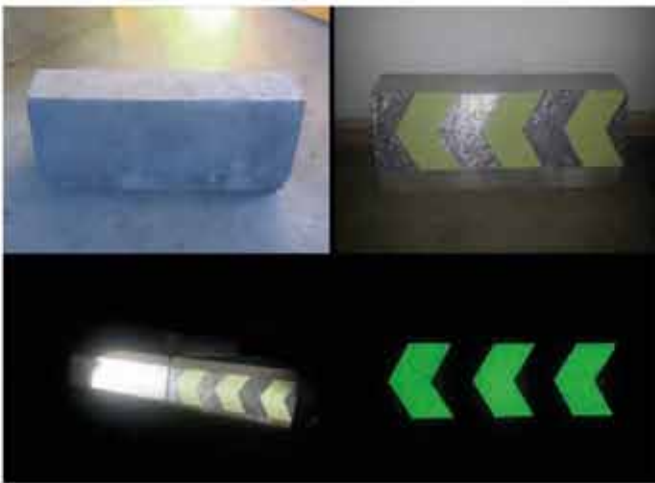

Ref.: 7105

Pintura luminiscente que acumula la luz en corto espacio de tiempo y la emite posteriormente en plena oscuridad, durante un largo periodo de tiempo.

Estas pinturas luminiscentes pueden activarse un número ilimitado de veces.

Colores disponibles:

- Amarillo verdoso.
- Transparente.



- Fácil aplicación: Paleta, brocha, rodillo, pistola.
- También en formato antideslizante.
- Aplicación sobre cualquier superficie.
- Muy resistente a los golpes.
- Secado al tacto en 30 min.



● Estacas de madera

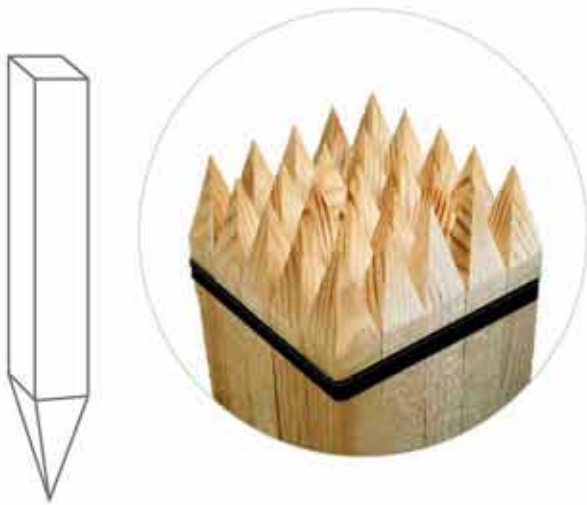

Ref.	Medidas	Und. paquete	Und. palet
4730	30 x 30 x 30 cm.	25	3.500
4735	30 x 30 x 35 cm.	25	3.200
4740	30 x 30 x 40 cm.	25	3.200
4750	30 x 30 x 50 cm.	25	2.775

● Spray S Mark



Azul Fluo



Verde Fluo



Rojo Fluo



Naranja Fluo



Rosa Fluo



Amarillo Fluo



Ref.	Descripción	Und. caja
7000	Color: rojo	12
7001	Color: azul	12
7002	Color: amarillo	12
7003	Color: verde	12
7004	Color: rosa	12
7005	Color: naranja	12

● Spray Constru Mark



Rojo Fluo



Azul Fluo



Amarillo Fluo



Rosa Fluo

Ref.	Descripción	Und. caja
7010	Color: rojo	12
7011	Color: azul	12
7012	Color: amarillo	12
7014	Color: rosa	12

● Spray 600 ml. LINE MARKER



Ref.	Descripción	Und. caja	Cajas palet
7020	Color: blanco	12	20
7022	Color: amarillo	12	20





PROHIBIDO FUMAR

Ref. 0230



PROHIBIDO EL PASO A TODA PERSONA AJENA A LA OBRA

Ref. 0231



PROHIBIDO PASAR SIN CASCO

Ref. 0232



PROHIBIDO FUMAR Y ENCENDER FUEGO

Ref. 0233



PROHIBIDO APAGAR CON AGUA

Ref. 0234



PROHIBIDO A LOS VEHICULOS DE MANUTENCION

Ref. 0235



PROHIBIDO EL USO A PERSONAS

Ref. 0237



VADO PERMANENTE

Ref. 0251



PROHIBIDO EL PASO A TODA PERSONA AJENA A ESTA EMPRESA

Ref. 0253



PROHIBIDO DEPOSITAR MATERIALES MANTENER LIBRE EL PASO

Ref. 0259



PROHIBIDO MANIPULAR LA VALVULA AL PERSONAL NO AUTORIZADO

Ref. 0273



PROHIBIDO ENGRASAR O REPARAR LA MAQUINA EN FUNCIONAMIENTO

Ref. 0274



PROHIBIDO EFECTUAR REPARACIONES POR PERSONAL NO AUTORIZADO

Ref. 0275



PROHIBIDO MANIPULAR LA MAQUINA EN FUNCIONAMIENTO

Ref. 0276



PROHIBIDO LA ENTRADA CON FERROS

Ref. 0278



PROHIBIDO ARROJAR OBJETOS AL SUELO

Ref. 0279



ALTO NO PASAR

Ref. 0280



AGUA NO POTABLE

Ref. 0281



PROHIBIDO EL PASO

Ref. 0282



PROHIBIDO TRANSPORTAR PERSONAS

Ref. 0283



Ref. 0249



PROHIBIDO APARCAR

Ref. 0248



PROHIBIDO SITUARSE DEBAJO DE LA CARGA

Ref. 0284



NO UTILIZAR EN CASO DE EMERGENCIA

Ref. 0285



NO UTILIZAR EN CASO DE INCENDIO

Ref. 0286



PROHIBIDO ACCIONAR O MANIOBRAR

Ref. 0288



NO TOCAR

Ref. 0292



PROHIBIDO PASAR A LOS PEATONES

Ref. 0302



RAMPA USO EXCLUSIVO PERSONAL AUTORIZADO

Ref. 0303



PROHIBIDO EL PASO

Ref. 0374



PROHIBIDA LA ENTRADA CON MARCAPASOS

Ref. 0310



SOLO PERSONAL AUTORIZADO

Ref. 0316



PROHIBIDO EL PASO CON BICICLETA

Ref. 0317



PROHIBIDO EL USO DE TELEFONOS MOVILES

Ref. 0318



PROHIBIDO BEBER Y COMER

Ref. 0370



VELOCIDAD MAXIMA

Ref. 0392



VELOCIDAD MAXIMA

Ref. 0393



VELOCIDAD MAXIMA

Ref. 0394



VELOCIDAD MAXIMA

Ref. 0395



Ref. 0210



Ref. 0211



Ref. 0212



Ref. 0213



Ref. 0214



Ref. 0215



Ref. 0216



Ref. 0217



Ref. 0218



Ref. 0219



Ref. 0236



Ref. 0238



Ref. 0240



Ref. 0250



Ref. 0252



Ref. 0255



Ref. 0257



Ref. 0260



Ref. 0385



Ref. 0384



Ref. 0386



Ref. 0383



Ref. 0381



Ref. 0382





Ref. 0267



Ref. 0268



Ref. 0269



Ref. 0270



Ref. 0272



Ref. 0277



Ref. 0287



Ref. 0290



Ref. 0291



Ref. 0293



Ref. 0294



Ref. 0295



Ref. 0311



Ref. 0312



Ref. 0313



Ref. 0314



Ref. 0372



Ref. 0373



Ref. 0265



Ref. 0266



Ref. 0315



Ref. 0371



Ref. 0375



Ref. 0247



Ref. 0376



Ref. 0220



Ref. 0221



Ref. 0222



Ref. 0223



Ref. 0224



Ref. 0225



Ref. 0226



Ref. 0227



Ref. 0228



Ref. 0229



Ref. 0299



Ref. 0300



Ref. 0301



Ref. 0304



Ref. 0305



Ref. 0306



Ref. 0307



Ref. 0308



Ref. 0309



Ref. 0377



Ref. 0378



Ref. 0379



Ref. 0387



Ref. 0380



Ref. 0388

● PVC de 1 mm. - Interior / exterior - Medidas: 40 x 30 cm.

FOTOLUMINISCENTES



Ref. 0262



Ref. 0261



Ref. 0263



Ref. 0264



Ref. 0256



Ref. 0340



Ref. 0201



Ref. 0296



Ref. 0297



Ref. 0289

● PVC de 1 mm. - Interior / exterior - Medidas: 21 x 29 cm.

FOTOLUMINISCENTES



Ref. 0396



Ref. 0346



Ref. 0347



Ref. 0343



Ref. 0258



Ref. 0349



Ref. 0351



Ref. 0350



Ref. 0298





Ref. 0320



Ref. 0321



Ref. 0322



Ref. 0323



Ref. 0324



Ref. 0325



Ref. 0326



Ref. 0327



Ref. 0332



Ref. 0333



Ref. 0334



Ref. 0335



Ref. 0336



Ref. 0337



Ref. 0338



Ref. 0339



Ref. 0344



Ref. 0397



Ref. 0398



Ref. 0367





Ref. 0202



Ref. 0203



Ref. 0206



Ref. 0207



Ref. 0355



Ref. 0356



Ref. 0358



Ref. 0365



Ref. 0359



Ref. 0362



Ref. 0364



Ref. 0366



Ref. 0208



Ref. 0357



Ref. 0204



Ref. 0209



Ref. 0205



Ref. 0328



Ref. 0329



Ref. 0330

● Cartelería informativa



Ref. 0399
Medida: 40 x 30cm.



Ref. 0363
Medida: 40 x 30cm.

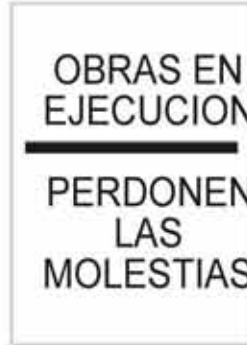

Ref. 0361
Medida: 40 x 30cm.



Ref. 0360
Medida: 40 x 30cm.



Ref. 0389
Medida: 50 x 70cm.
Material: Polipropileno Celular.



Ref. 0241
Medida: 40 x 30cm.



Ref. 0242
Medida: 40 x 30cm.



Ref. 0369
Medida: 21 x 29cm.



Ref. 0348
Medida: 15 x 15cm.



Ref. 0352
Medida: 21 x 21cm.



Ref. 0353
Medida: 21 x 21cm.



Ref. 0354
Medida: 21 x 15cm.

Material: Polipropileno celular

● Fabricación personalizada de cartelería.

Recuerde: Somos fabricantes. Si en estas referencias no encuentra la señal que necesita, no dude en consultarnos.





Ref. 0244

Medida: 100 x 70 cm.



Ref. 0390

Medida: 50 x 70 cm.



Ref. 0342

Medida: 40 x 60 cm.

● Adhesivos 15 x 10 cm.



Ref. 8201



Ref. 8210



Ref. 8216



Ref. 8218



Ref. 8219



Ref. 8220



Ref. 8221



Ref. 8222



Ref. 8223



Ref. 8226



Ref. 8227



Ref. 8230



Ref. 8232



Ref. 8238



Ref. 8250



Ref. 8252



Ref. 8253



Ref. 8256



Ref. 8275



Ref. 8281



Ref. 8283



Ref. 8290



Ref. 8291



Ref. 8374



Ref. 8375



Ref. 8381



Ref. 8382



Ref. 8384



Ref. 8385

Cualquier otro pictograma consultar.

● Señal bolsa de plástico serigrafiada 70 x 70 cm.



Ref. 0401



Ref. 0402



Ref. 0403



Ref. 0404



Ref. 0405



Ref. 0406



Ref. 0407



Ref. 0408



Ref. 0409



Ref. 0410



Ref. 0411



Ref. 0412



Ref. 0413



Ref. 0414



Ref. 0415



Ref. 0416



Ref. 0417



Ref. 0418



Ref. 0419



Ref. 0420



Ref. 0421



Ref. 0422



Ref. 0423



Ref. 0424



Ref. 0425



Ref. 0426



Ref. 0427

Cualquier otro pictograma consultar.
Todas estas señales se pueden servir con fondo blanco.



Ref. 0600



Ref. 0601



Ref. 0602



Ref. 0603



Ref. 0604



Ref. 0605



Ref. 0606



Ref. 0607



Ref. 0608



Ref. 0609



Ref. 0610



Ref. 0611



Ref. 0612



Ref. 0613



Ref. 0614



Ref. 0615



Ref. 0616



Ref. 0617



Ref. 0619



Ref. 0620



Cualquier otro pictograma consultar.
Todas estas señales se pueden servir con fondo blanco.



Ref. 0630



Ref. 0641



Ref. 0642



Ref. 0643



Ref. 0644



Ref. 0645



Ref. 0647



Ref. 0648



Ref. 0649



Ref. 0650



Ref. 0651



Ref. 0652



Ref. 0656



Ref. 0657



Ref. 0663



Ref. 0670



Ref. 0671



Ref. 0672



Ref. 0674



Ref. 0629

● **Señales metálicas económicas definitivas**



Ref. 0624
Med: 50 x 50cm.



Ref. 0625
Med: 50 x 50cm.



Ref. 0665
Med: 50 x 50cm.



Ref. 0666
Med: 50 x 50cm.



Ref. 0678
Med: 50 x 50cm.



Ref. 0628
Diámetro: 50cm.



Ref. 0653
Diámetro: 50cm.



Ref. 0662
Diámetro: 50cm.



Ref. 0664
Diámetro: 50cm.



Ref. 0668
Diámetro: 50cm.



Ref. 0661
Diámetro: 50cm.



Ref. 0673
Medida: 70cm.

● **Señales complementarias informativas.**



Ref. 0719
Placa
Coto privado de caza
50x33



Ref. 0720
Placa
Coto de caza
50x33

Ejemplo



Económica



Ref. 0680 - 40 x 20cm.
Ref. 0688 - 55 x 35cm.

Económica



Ref. 0679 - 40 x 20cm.
Ref. 0687 - 55 x 35cm.

● **Vado permanente en aluminio**



Ref.	Descripción	Und. caja
0682	Vado permanente aluminio.	1

señalética
M.O.P.U.
definitiva



señalética M.O.P.U.

Señales metálicas M.O.P.U. definitivas

● Señales de indicación general



S-1



S-8



S-11



S-12



S-13



S-15A



S-15B



S-15C



S-15D



M-1



S-17



S-18



S-19



S-22



S-23



S-24



S-28



S-1



S-3



S-5



M-2

● Señales de prioridad



R-1



R-2



R-3



R-4



R-5



R-6

● Señales de advertencia de peligro



● Señales de prohibición



● Señales de obligación



● Señal metálica M.O.P.U. triangular



Disponible en todos los iconos de la páginas 68 y 69.

Dimensiones	Normal	Reflex N1	Reflex N2	Reflex N3
70 cm.	9070N	9070N1	9070N2	9070N3
90 cm.	9090N	9090N1	9090N2	9090N3
135 cm.	90135N	90135N1	90135N2	90135N3
175 cm.	--	90175N1	90175N2	90175N3

● Señal metálica M.O.P.U. disco



Disponible en todos los iconos de la páginas 68 y 69.

Dimensiones	Normal	Reflex N1	Reflex N2	Reflex N3
60 cm.	9160N	9160N1	9160N2	9160N3
90 cm.	9190N	9190N1	9190N2	9190N3
120 cm.	91120N	91120N1	91120N2	91120N3

● Señal metálica M.O.P.U. octogonal



Dimensiones	Normal	Reflex N1	Reflex N2	Reflex N3
60 cm.	9260N	9260N1	9260N2	9260N3
90 cm.	9290N	9290N1	9290N2	9290N3

● Señal metálica M.O.P.U. cuadrados



Disponible en todos los iconos de la páginas 68 y 69.

Dimensiones	Normal	Reflex N1	Reflex N2	Reflex N3
40 x 40 cm.	9340N	9340N1	9340N2	9340N3
60 x 60 cm.	9360N	9360N1	9360N2	9360N3
90 x 90 cm.	9390N	9390N1	9390N2	9390N3

● Señal metálica M.O.P.U. rectangular



Dimensiones	Normal	Reflex N1	Reflex N2	Reflex N3
40 x 60 cm.	944060N	944060N1	944060N2	944060N3
60 x 90 cm.	946090N	946090N1	946090N2	946090N3
60 x 120 cm.	9460120N	9460120N1	9460120N2	9460120N3
90 x 135 cm.	9490135N	9490135N1	9490135N2	9490135N3
120 x 180 cm.	94120180N	94120180N1	94120180N2	94120180N3
120 x 210 cm.	94120210N	94120210N1	94120210N2	94120210N3

Cualquier otra señal consultar.

Placas complementarias M.O.P.U. definitivas

CAMBRILS

BARCELONA

Dimensiones	Normal	Reflex N1	Reflex N2	Reflex N3
25 x 70 cm.	962570N	962570N1	962570N2	962570N3
25 x 95 cm.	962595N	962595N1	962595N2	962595N3
25 x 120 cm.	9625120N	9625120N1	9625120N2	9625120N3
25 x 145 cm.	9625145N	9625145N1	9625145N2	9625145N3
25 x 170 cm.	9625170N	9625170N1	9625170N2	9625170N3
25 x 195 cm.	9625195N	9625195N1	9625195N2	9625195N3
25 x 220 cm.	9625220N	9625220N1	9625220N2	9625220N3
30 x 70 cm.	963070N	963070N1	963070N2	963070N3
30 x 95 cm.	963095N	963095N1	963095N2	963095N3
30 x 120 cm.	9630120N	9630120N1	9630120N2	9630120N3
30 x 145 cm.	9630145N	9630145N1	9630145N2	9630145N3
30 x 170 cm.	9630170N	9630170N1	9630170N2	9630170N3
30 x 195 cm.	9630195N	9630195N1	9630195N2	9630195N3
30 x 220 cm.	9630220N	9630220N1	9630220N2	9630220N3
40 x 70 cm.	964070N	964070N1	964070N2	964070N3
40 x 95 cm.	964095N	964095N1	964095N2	964095N3
40 x 120 cm.	9640120N	9640120N1	9640120N2	9640120N3
40 x 145 cm.	9640145N	9640145N1	9640145N2	9640145N3
40 x 170 cm.	9640170N	9640170N1	9640170N2	9640170N3
40 x 195 cm.	9640195N	9640195N1	9640195N2	9640195N3
40 x 220 cm.	9640220N	9640220N1	9640220N2	9640220N3

Dimensiones	Normal	Reflex N1	Reflex N2	Reflex N3
45 x 70 cm.	964570N	964570N1	964570N2	964570N3
45 x 95 cm.	964595N	964595N1	964595N2	964595N3
45 x 120 cm.	9645120N	9645120N1	9645120N2	9645120N3
45 x 145 cm.	9645145N	9645145N1	9645145N2	9645145N3
45 x 170 cm.	9645170N	9645170N1	9645170N2	9645170N3
45 x 195 cm.	9645195N	9645195N1	9645195N2	9645195N3
45 x 220 cm.	9645220N	9645220N1	9645220N2	9645220N3
55 x 70 cm.	965570N	965570N1	965570N2	965570N3
55 x 95 cm.	965595N	965595N1	965595N2	965595N3
55 x 120 cm.	9655120N	9655120N1	9655120N2	9655120N3
55 x 145 cm.	9655145N	9655145N1	9655145N2	9655145N3
55 x 170 cm.	9655170N	9655170N1	9655170N2	9655170N3
55 x 195 cm.	9655195N	9655195N1	9655195N2	9655195N3
55 x 220 cm.	9655220N	9655220N1	9655220N2	9655220N3
95 x 70 cm.	969570N	969570N1	969570N2	969570N3
95 x 95 cm.	969595N	969595N1	969595N2	969595N3
95 x 120 cm.	9695120N	9695120N1	9695120N2	9695120N3
95 x 145 cm.	9695145N	9695145N1	9695145N2	9695145N3
95 x 170 cm.	9695170N	9695170N1	9695170N2	9695170N3
95 x 195 cm.	9695195N	9695195N1	9695195N2	9695195N3
95 x 220 cm.	9695220N	9695220N1	9695220N2	9695220N3

Placas complementarias M.O.P.U. definitivas

Paneles direccionales fijos para señalización Curvas Peligrosas (azul y blanco)



Dimensiones	Normal	Reflex N1	Reflex N2	Reflex N3
40 x 20 cm.	954020N	954020N1	954020N2	954020N3
60 x 20 cm.	956020N	956020N1	956020N2	956020N3
60 x 30 cm.	956030N	956030N1	956030N2	956030N3
85 x 20 cm.	958520N	958520N1	958520N2	958520N3
60 x 40 cm.	956040N	956040N1	956040N2	956040N3
90 x 30 cm.	959030N	959030N1	959030N2	959030N3
80 x 40 cm.	958040N	958040N1	958040N2	958040N3

Dimensiones	Normal	Reflex N1	Reflex N2	Reflex N3
80 x 40 cm.	978040N	978040N1	978040N2	978040N3
165 x 45 cm.	9716545N	9716545N1	9716545N2	9716545N3



Señales metálicas M.O.P.U. Obras

● Señales de advertencia de peligro

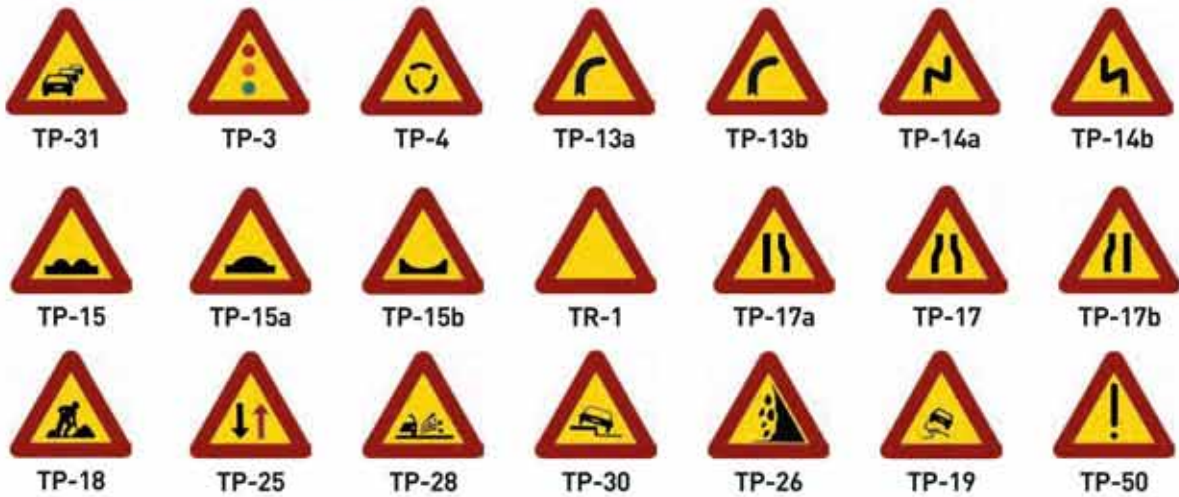

● Señales de prohibición

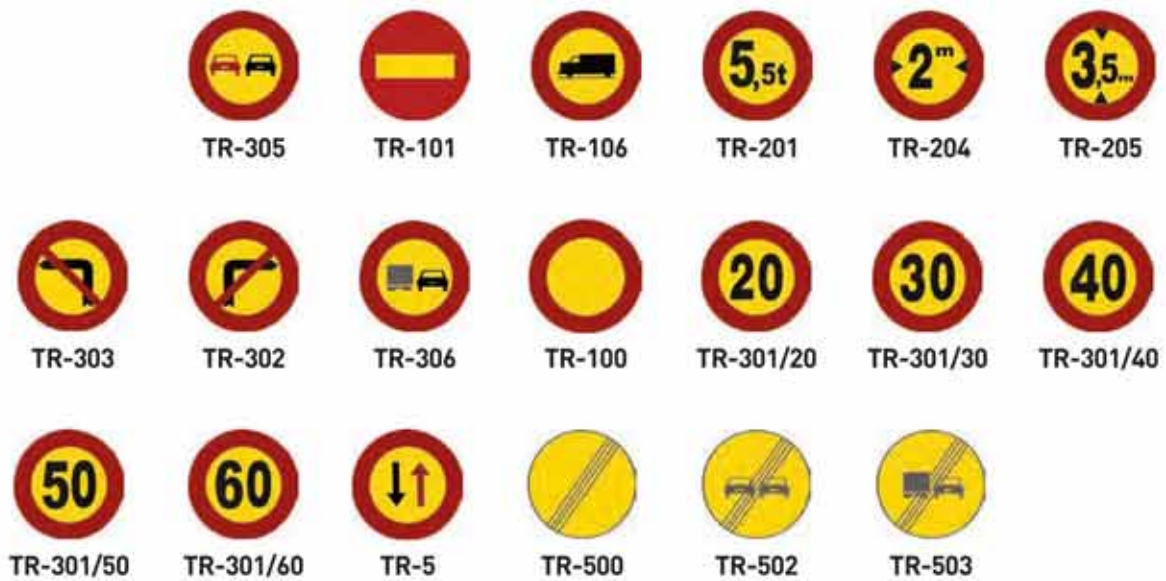

● Señales de obligación



● Señal metálica M.O.P.U. triangular



Disponible en todos los iconos de la páginas 66 y 67.

Dimensiones	Reflex N1	Reflex N2	Reflex N3
70 cm.	8070N1	8070N2	8070N3
90 cm.	8090N1	8090N2	8090N3
135 cm.	80135N1	80135N2	80135N3
175 cm.	80175N1	80175N2	80175N3

● Señal metálica M.O.P.U. disco



Disponible en todos los iconos de la páginas 66 y 67.

Dimensiones	Reflex N1	Reflex N2	Reflex N3
60 cm	8160N1	8160N2	8160N3
90 cm	8190N1	8190N2	8190N3
120 cm	81120N1	81120N2	81120N3

● Placas complementarias M.O.P.U. obras



Dimensiones	Reflex N1	Reflex N2	Reflex N3
40 x 20 cm.	854020N1	854020N2	854020N3
60 x 30 cm.	856030N1	856030N2	856030N3

● Señal metálica M.O.P.U. cuadrados

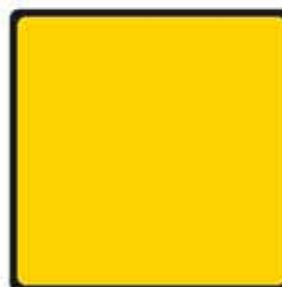

Disponible en todos los iconos de la páginas 66 y 67.

Dimensiones	Reflex N1	Reflex N2	Reflex N3
40 x 40 cm.	8340N1	8340N2	8340N3
60 x 60 cm.	8360N1	8360N2	8360N3
90 x 90 cm.	8390N1	8390N2	8390N3

● Señal metálica M.O.P.U. rectangular



Dimensiones	Reflex N1	Reflex N2	Reflex N3
40 x 60 cm.	844060N1	844060N2	844060N3
60 x 90 cm.	846090N1	846090N2	846090N3
60 x 120 cm.	8460120N1	8460120N2	8460120N3
90 x 135 cm.	8490135N1	8490135N2	8490135N3
120 x 180 cm.	84120180N1	84120180N2	84120180N3
120 x 210 cm.	84120210N1	84120210N2	84120210N3



● Paneles direccionales moviles para señalización Peligro de Obras, Desvios (rojo y blanco)

TB - 1



TB - 2



Dimensiones	Reflex N1	Reflex N2	Reflex N3
195 x 95 cm.	8719595N1	8719595N2	8719595N3
165 x 45 cm.	8716545N1	8716545N2	8716545N3
80 x 40 cm.	878040N1	878040N2	878040N3

● Balizas delimitación obras

TB - 7 TB - 8 TB - 9 TB - 11



Referencia	Descripción	
883010N1	Piqueta 30 x 10 cm. TB-7	REFLEX
887015dN1	Baliza 70 x 15 cm. TB-8	REFLEX
887015iN1	Baliza 70 x 15 cm. TB-9	REFLEX
8840N1	Piqueta 40 cm. de jalonamiento TB-11	REFLEX
884030N1	Placa 40 x 30 cm. "Escalón lateral" con piqueta	REFLEX

● Balizas delimitación obras



Ref.	Descripción
8819560N1	Panel Hastial 195 x 60 cm. REFLEX-N1
889530N1	Panel Hastial 95 x 30 cm. REFLEX-N1
889530N2	Panel Hastial 95 x 30 cm. REFLEX-N2

herramientas



herramientas

02

● Lápices



Ref.	Descripción	Unds. caja
2035	Lapicero carpintero.	80
2036	Lapicero metálico recargable.	50
2037	Recambios.	250

● Clavo yesero



Ref.	Descripción	Uds. caja
2901	Clavo yesero.	48

● Mezclador pintura



Ref.	Descripción	Uds. caja
2969	Metálico 80 mm.	40
2971	Metálico 100 mm.	40

● Frotas esponja azul - grano fino



Ref.	Descripción	Medidas	Uds. caja
2520	Dureza: media. Espesor: 15 mm.	22 x 14 cm.	32

● Frotas esponja naranja - grano grueso



Ref.	Descripción	Medidas	Uds. caja
2413	Dureza: blanda. Espesor: 20 mm .	28 x 14 cm.	40

● Frotas esponja naranja - grano fino



Ref.	Descripción	Medidas	Uds. caja
2414	Dureza: alta. Espesor: 10 mm.	28 x 14 cm.	40

● Frotas esponja naranja - grano medio



Ref.	Descripción	Medidas	Uds. caja
2519	Dureza: media. Espesor: 15 mm.	22 x 14 cm.	32

● Toldo polietileno azul 80 gr.



Ref.	Medidas	Uds. caja
2060	2 x 3	40
2061	3 x 4	20
2058	3 x 5	20
2059	4 x 5	15
2062	4 x 6	10
2063	5 x 8	6
2064	6 x 10	4
2065	8 x 12	2
2066	10 x 15	1

● Toldo polietileno verde 120 gr.



Ref.	Medidas	Uds. caja
2050	2 x 3	30
2051	3 x 4	15
2052	4 x 6	8
2053	5 x 8	5
2054	6 x 10	3

Malla fibra vidrio 4 x 4 Blanco Yeso

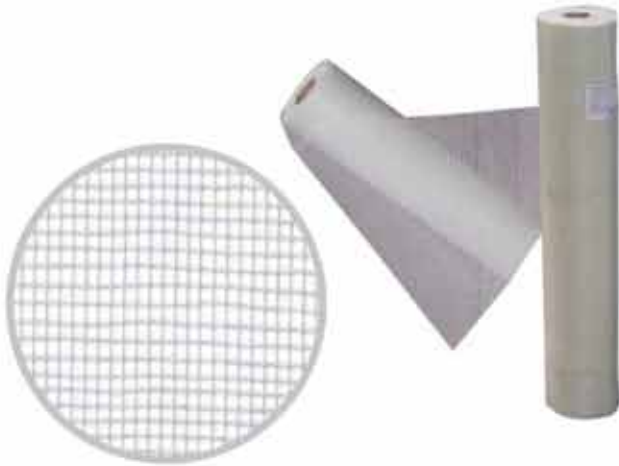

Ref.	Medidas	Uds. caja
4702	Color: blanco - 1 x 50 m.	4

Malla fibra vidrio 10 x 10, Azul Reboco

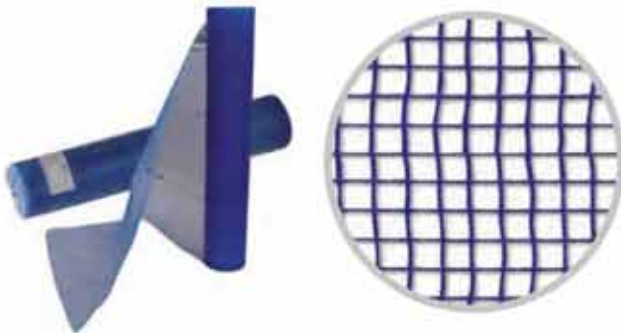

Ref.	Medidas	Uds. caja	Uds. palet
4703	Color: azul - 1 x 50 m.	4	60

Blister Malla ocultación 3,50 x 1,90 mt



Ref.	Medidas	Uds. caja	Uds. palet
4894	manto 3,50 x 1,90 m.	20	60

Malla sombreo/ocultación



70% opacidad



80% opacidad



90% opacidad



Ref.	Descripción
4890	m ² malla 70% opacidad
4891	m ² malla 80% opacidad
4892	m ² malla 90% opacidad

Medidas disponibles en rollo:

- 1 m x 100 m.
- 1,5 m x 100 m.
- 2 m x 100 m.

Colores:

- Verde oscuro
- Negro

Disponible en mantos a medida

Ref.	Descripción
4897	m ² malla 70% opacidad
4898	m ² malla 80% opacidad
4899	m ² malla 90% opacidad



Malla protección andamio/fachada



Ref.	Descripción
4888	m ² malla extra.



Colores disponibles: Det. Malla Extra.

Ref.	Descripción
4887	m ² malla standard.



Colores disponibles: Det. Malla Standard.

Malla protección naranja



Ref.	Descripción	Und. palet
4700	Rollo 1 x 50m. 80g	96
4701	Rollo 1 x 50m. 100g	112

Malla señalización monofilamento



Colores disponibles:
Posibilidad de personalizar (consultar).

Ref.	Descripción	Und. palet
4895/A	Rollo 1 x 100m. Color Amarillo	50
4895/R	Rollo 1 x 100m. Color Rojo	50

Malla anti-hierba



Negro

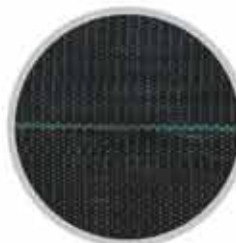

Verde



Medidas disponibles en rollo:

- 1 m x 100 m.
- 1,5 m x 100 m.
- 2 m x 100 m.
- 3 m x 100 m.
- 4 m x 100 m.
- 5 m x 100 m.

Ref.	Descripción
4893	m ² malla

● Bolsa encofrador



Ref.	Descripción	Medidas	Uds. caja
2040	Polipiel. 1 bolsillo.	21 x 21 cm.	50

● Bolsa encofrador



Ref.	Descripción	Medidas	Uds. caja
2043	Polipiel. 2 bolsillos.	29 x 21 cm.	25

● Octómetro con mochila



Ref.	Descripción	Uds. caja
2039	Rueda cuentametros.	4

● Rodillo de marcar

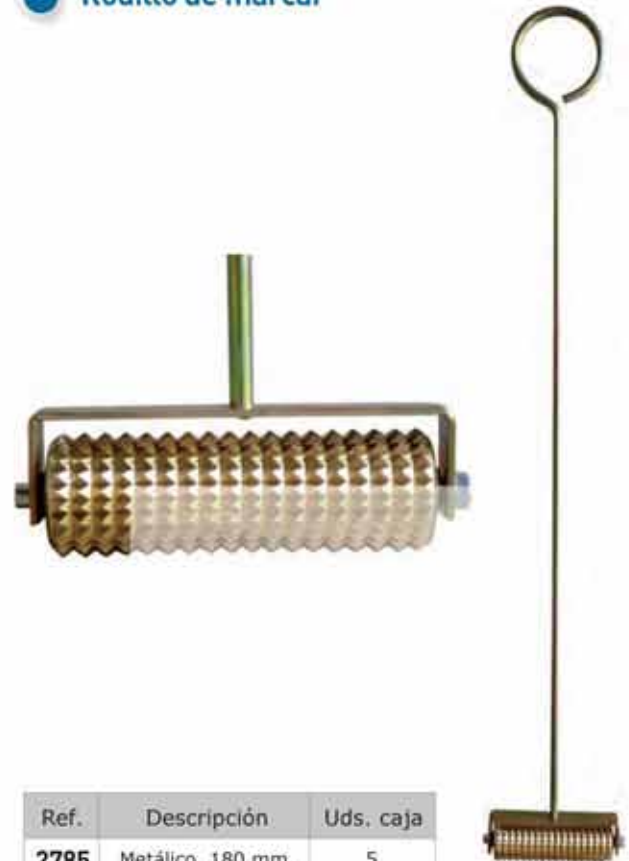

Ref.	Descripción	Uds. caja
2785	Metálico. 180 mm.	5

● Tirolesa



Ref.	Descripción	Uds. caja
2038	Acero inoxidable.	6

● Caldereta de obra y Capazo



Ref.	Descripción	Uds. bolsa	Uds. Palet
2700	Caldereta obra polit. 15 l.	15	270
2702	Capazo de goma 42 l.	12	504

● Cuerda trazadora

Ref.	Descripción	Metros	Uds caja
2674	Bobina.	50	100
2675	Bobina.	100	100
2676	Bobina.	200	64
2677	Bobina.	500	10



● Cuerda cervino

Ref.	Diametro	Metros
4004	4 mm.	100
4006	6 mm.	100
4008	8 mm.	100
4010	10 mm.	100
4012	12 mm.	100
4014	14 mm.	100
4016	16 mm.	100
4018	18 mm.	100
4020	20 mm.	100



● Cuerda certificada poliéster alta tenacidad

Ref.	Diametro	Carga rotura	Metros
4106	6 mm.	6,5 (+-) 0,6 kN.	100
4108	8 mm.	13,7 (+-) 0,9 kN.	100
4110	10 mm.	17,2 (+-) 0,9 kN.	100
4112	12 mm.	18,1 (+-) 0,9 kN.	100
4114	14 mm.	24,6 (+-) 1,6 kN.	100
4116	16 mm.	25,3 (+-) 1,1 kN.	100
4118	18 mm.	28,0 (+-) 1,1 kN.	100

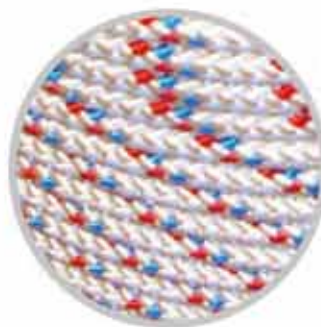

Normativas:
 UNE-EN 1263-1:2004
 UNE-EN ISO 2307:2005
 IE080022 registro: 33006
 Certificado: AIDICO

● Azulete gaviota



Ref.	Descripción	Uds. caja
2239	Botella 500 gr.	12
2238	Caja 1 kg.	20

● Botellas azulete



Ref.	Descripción	Uds. caja
2234	Cat. Extra - 1 kg.	24
2235	Cat. Super extra - 1 kg.	12

● Fluomark



Ref.	Descripción	Uds. caja
2236	Botella 200 gr. - Verde.	6
2237	Botella 200 gr. - Naranja.	6

Tiralíneas Gigante



Capacidad aprox.: 300 gr.
Cordón: Algodón trenzado de 2,5 mm.

Ref.	Descripción	Uds. caja
2240	50 m. cordón extra.	12

Tiralíneas Magnum



Capacidad aprox.: 300 gr.
Cordón: Algodón trenzado de 2,5 mm.
Empuñadura ergonómica con mayor grip.

Ref.	Descripción	Uds. caja
2245	50 m.	12



● Tiralíneas Normo



Ref.	Descripción	Uds. caja
2244	30 m.	12 tiralíneas + 12 bot. 100 gr.

● Tiralíneas Americano plástico



Capacidad aprox.: 100 gr.
Cordón: 1 mm.
Presentación: Blister

Ref.	Descripción	Und. caja
2241	Botella plástico 100 gr. Tiralíneas 30 m.	12

● Tiralíneas aluminio



Capacidad aprox.: 100 gr.
Cordón: 1 mm.
Presentación: Blister

Ref.	Descripción	Und. caja
2242	Tiralíneas 30 m.	12

utillaje construcción



utillaje construcción

03

Perfiles acero inox. alto brillo

Guardacantos acero inox alto brillo 12,5mm



Ref.	Und. caja	Peso	Metros lineales
3415	40 unid x 2,60 mts.	699 gr.	104

Nivel acero inox alto brillo 12x10mm



Ref.	Und. caja	Peso	Metros lineales
3400	20 unid x 2,60 mts.	699 gr.	52

Perfiles acero inox. alto brillo

● Perfil "U" acero inox 8x10 mm

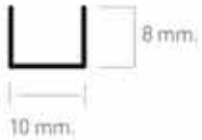

Ref.	Und. caja	Peso	Metros lineales
3420	25 unid x 2,50 mts.	260 gr.	62,5

● Perfil "U" acero inox 8x15 mm

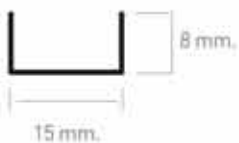

Ref.	Und. caja	Peso	Metros lineales
3421	25 unid x 2,50 mts.	372 gr.	62,5

● Tubo encofrado Estriado Ø 26/30



Ref.	Descripción	Medida barra	Mts. paquete	Mts. palet
3300	Ø 22/26	3 m.	75	5.400 m.
3301	Ø 22/26	2 m.	50	5.400 m.
3302	Ø 26/30	2 m.	40	1.920 m.

● Tapón y cono para tubo encofrado



Ref.	Descripción	Uds. caja	Uds. palet
3391	Cono Ø22	1000	72.000
3396	Tapón Ø22	1000	100.000
3390	Cono Ø26	1000	52.000
3397	Tapón Ø26	1000	52.000

● Tapón estanco



Ref.	Descripción	Uds. bolsa	Uds. palet
3394	P/tubo 22	500	120.000

● Cono y tapón encofrado liso



Ref.	Descripción	Uds. bolsa	Uds. palet
3392	Cono Ø22	500	52.000
3393	Tapón Ø22	500	100.000

● Etubax con tapones

Ref.	Descripción	Uds. caja	Uds. Palet
3306	Tubo Etubax 20.	50	5000
3307	Tubo Etubax 25.	50	5000
3308	Tubo Etubax 30.	50	5000
3309	Tubo Etubax 35.	40	4000
3310	Tubo Etubax 40.	30	3000



● Separador rueda

Ref.	Medidas	Uds. caja	Uds. palet
3370	25 mm.	1000	54.000
3371	30 mm.	1000	54.000
3372	35 mm.	500	20.000
3373	40 mm.	500	18.000
3374	50 mm.	250	13.500
3375	60 mm.	250	9.000
3376	70 mm.	150	7.000

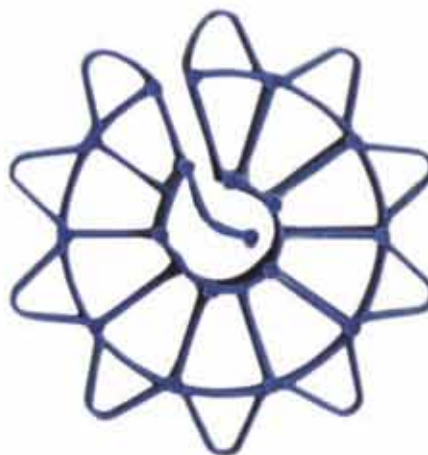

● Separador universal



Ref.	Uds. caja	Uds. palet
3032	1000	80.000

● Separador cóndor



Ref.	Medidas	Uds. caja	Uds. palet
3030	20 mm.	1000	80.000
3031	40 mm.	500	40.000
3035	30 mm.	1000	60.000
3038	50 mm.	500	25.000

● Crucetas

Ref.	Medidas	Uds. caja
2658	3 mm.	300
2659	5 mm.	300
2660	7 mm.	150
2661	10 mm.	100
2662	3 mm.	500
2663	5 mm.	500
2664	7 mm.	500
2665	10 mm.	500



● Distanciador cuña 0/7



Ref.	Uds. bolsa	Uds. palet
3015	200	32.000



● Base horca pescante



Ref.	Medidas	Uds. caja	Uds. palet
3037	60 x 60	45	1.350

● Base guardacuerpo cuadrado - redondo



Ref.	Medidas	Uds. caja	Uds. palet
3034	Rec. Cuad. 35 x 40	150	5.400

● Seta protectora con incrustación metálica



Ref.	Uds. bolsa	Uds. palet
3043	100	20.000

● Cono guardacuerpos



Ref.	Descripción	Uds. caja	Uds. palet
3033	Con tapa.	200	8.000

● Seta protectora



Ref.	Descripción	Uds. caja	Uds. palet
3039	8/22	100/300	20.000
3041	Cuadrada 35 x 40	100	20.000
3042	Varilla 24/40	200	6.000

Guardavivo yeso



Ref.	Medidas	Uds. x caja	Mts. palet	Cajas palet
3250	23,5 mm.	100 Tiras x 2,60 m. (260 m/caja).	13.000	40

Junquillo



Ref.	Medidas	Uds. x caja	Mts. palet	Cajas palet
3254	20 mm.	130 Barras x 2 m. (260m/caja).	8.000 m.	40

Guardacantos

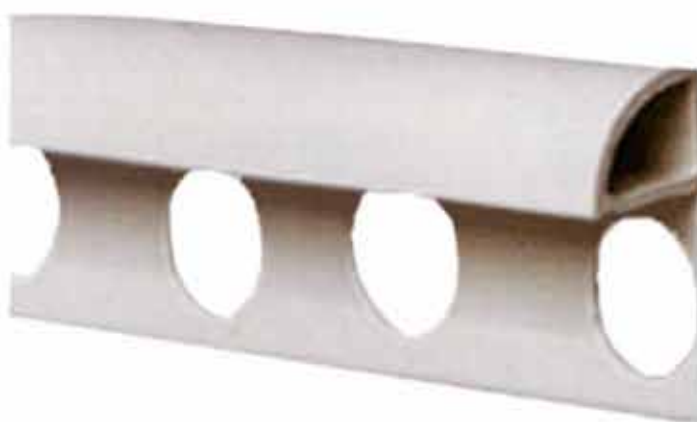
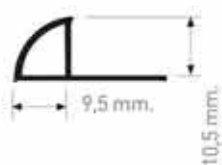

Ref.	Descripción	Uds. x caja	Mts. palet	Cajas palet
3251	Color: blanco.	100 Barras x 2,60 m. (260 m/caja).	10.400 m.	40
3252	Color: marfil.	100 Barras x 2,60 m. (260 m/caja).	10.400 m.	40
3253	Color: gris.	100 Barras x 2,60 m. (260 m/caja).	10.400 m.	40

Berengeno

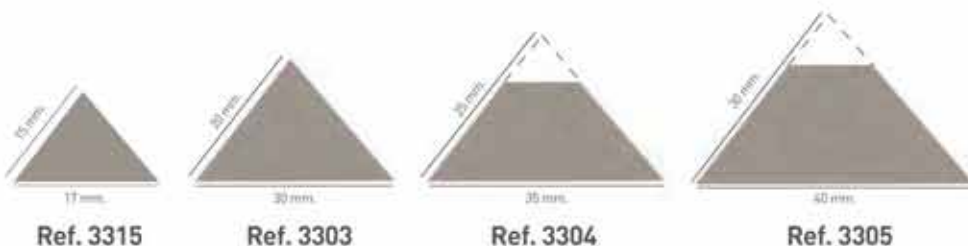

Ref. 3315

Ref. 3303

Ref. 3304

Ref. 3305

Ref.	Medidas	Uds. x caja	Metros palet	Cajas palet
3315	17 B x 15 a.	50 Tiras x 2,5 mts. (125m./caja)	2.500	20 Paq.
3303	30 B x 20 a.	50 Tiras x 2,5 mts. (125m./caja)	6.000	40 Paq.
3304	35 B x 25 a.	50 Tiras x 2,5 mts. (125m./caja)	5.000	40 Paq.
3305	40 B x 30 a.	50 Tiras x 2,5 mts. (125m./caja)	5.000	40 Paq.

Guardavivo monocapa punta fina



Ref.	Uds. x caja	Mts. palet	Cajas palet
3256	50 Tiras x 2,5 m. (125 m/caja)	5.200	40

Juntas de dilatación

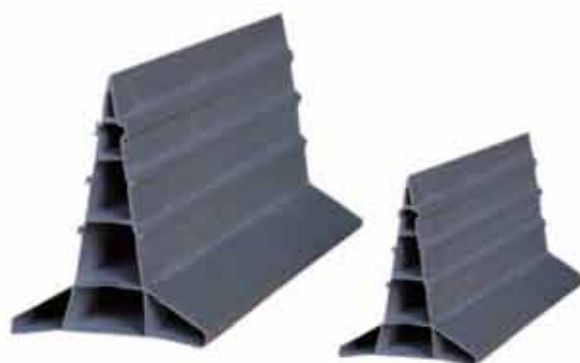

Ref.	Descripción	Uds. x caja	Metros palet	Cajas palet
3100	Junta 4 cm.	60 Tiras x 2,5 m. (150 m/caja).	2.250	15
3101	Junta 8 cm.	20 Tiras x 2,5 m. (50 m/caja).	750	15

Saco Big Bag



Ref.	Descripción	Uds. caja	Uds. palet
4300	850 x 850 x 900 - 1000 kg. 5:1. Puntada de seguridad + over loock en laterales, asas de 40 x 4 cm.	20	500

Saco Big Bag válvula



Ref.	Descripción	Uds. caja	Uds. palet
4301	850 x 850 x 900 - 1000 kg. 5:1. Puntada de seguridad + over loock en laterales, asas de 40 x 4 cm con valvula de vaciado inferior.	20	500

Saco Rafia 25 Kg.



Medidas: 55 x 85 cm.

Ref.	Descripción	Uds. palet
4304	Saco de Rafia 25 kg.	1.000

Saco plástico escombros



Ref.: 4305

Sacos plastico escombros Bolsa 10 unid.
Medidas: 75 x 55 cm.
Peso soportado aprox. 60 kg.

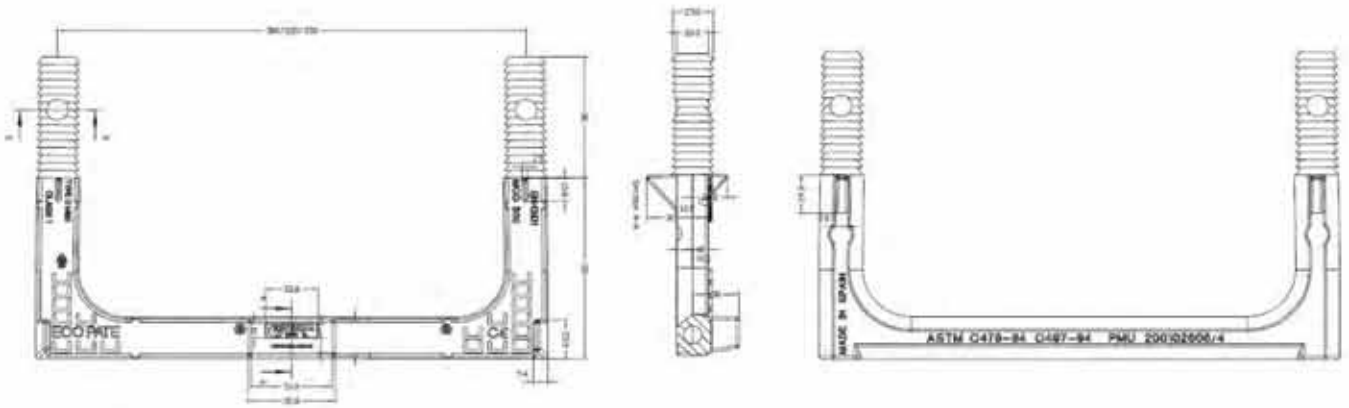

Características:

- Polipropileno o polietileno reforzado con acero calibrado con dureza de 65 Kg/mm².
- Adaptable a superficies curvas y rectas.
- Diseño ergonómico, compacto, robusto y con gran resistencia a impactos.
- Superficies y aletas laterales antideslizantes.
- Tope de golpeo para la correcta introducción del pate.
- Conformidad con normativa europea de calidad EN-13101.

Ref.	Descripción	Uds. caja	Uds. palet
4780	Pate 300 mm.	40	40

seguridad laboral



seguridad laboral

04

Gafa protectora G-1



CE

Máxima visión, impacto y protección UV.
Color transparente, acorde a EN166.

Ref.	Descripción	Und. caja
5100	gafa protectora de seguridad EN166 - Modelo: G-1.	200

Gafa protectora G-2



CE

Amplia visión, impacto y protección UV.
Acorde a EN166.

Ref.	Descripción	Und. caja
5101	gafa protectora de seguridad EN166 - Modelo: G-2.	100

Gafa protectora G-3



CE

Máximo confort, peso ligero, protección UV 400.
Color gris, acorde a EN166.

Ref.	Descripción	Und. caja
5102	gafa protectora de seguridad EN166 - Modelo: G-3.	150

Cascos Auditivos



CE

Cascos auditivos con excelente protección.
Ligeros, con copas acolchadas. Mod. A.
SNR 18 dB - EN 352-1.

Ref.	Descripción	Und. caja
5201	Cascos auditivos.	50

Tapones auditivos con cordón



CE

Tapones auditivos con cordón.
SNR 26 dB - EN 352-2.

Ref.	Descripción	Und. caja
5200	Tapones auditivos.	100



● Juego rodillera alicatador



Ref.	Uds. caja
2530	24

● Faja elástica protección lumbar



Ref.	Tallas	Uds. caja
5300	L - XL.	24



vestuario laboral



vestuario laboral

05

● Chaleco reflectante



Ref. 4690



Ref. 4691



CE

Ref. 4690 - 4691 - EN 471
Unidades caja: 100

Características

Chaleco fabricado en 100% poliéster.
Colores: amarillo y naranja fluorescente.
Bandas reflectantes.
Cierre con velcro.

● chaleco reflectante rejilla



CE

Ref. 4692 - EN 471
Unidades caja: 100

Características

Chaleco fabricado en tejido rejilla.
Ideal para el verano por su excelente ventilación.
Color: amarillo.
Bandas reflectantes.
Cierre con velcro.
1 Bolsillo identificador.
2 Bolsillos laterales.

● Tirantes alta visibilidad



CE

Ref. 4695 - EN 471 Amarillo.
Ref. 4696 - EN 471 Naranja.
Unidades caja: 100

Material 100% poliéster.
Tiras reflectantes.



Ref. 6201

Material: 100% poliéster PVC.
170 t.
Color: azul marino.

material eléctrico

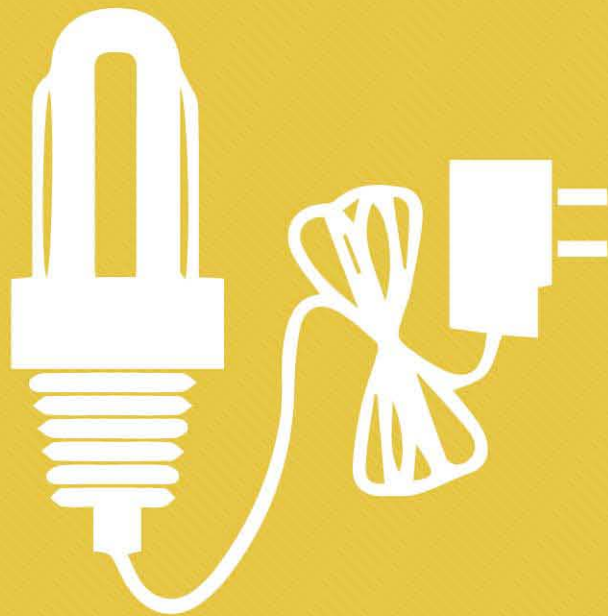

material eléctrico

06

 Foco halógeno con trípode



Referencia	2071
Descripción	Foco halógeno con trípode 500 W.
Und. caja	2

 Foco halógeno doble con trípode



Referencia	2073
Descripción	Foco halógeno con trípode 2 x 500 W.
Und. caja	2

Foco halógeno



Referencia	Descripción	Uds. caja
2068	1.500 W	6
2069	1.000 W	6
2070	500 W	20

Foco halógeno con soporte



Referencia	Descripción	Uds. caja
2072	Foco halógeno 500 W con soporte	6

CV Tools

CV Tools, S.L.

Avda. Camino de Albaida, s/n.
46830 BENIGNIM (Valencia)

Tel.: 96 292 01 32 - Fax: 96 221 58 36
cvtools@cvtools.es

www.cvtools.es